

This computer program (including software design, programming structure, graphics, manual, and on-line help) was created by StructurePoint, formerly the Engineering Software Group of the Portland Cement Association for engineering design and investigation of reinforced concrete sections subject to axial and flexural loads.

While StructurePoint has taken every precaution to utilize the existing state-of-the-art and to assure the correctness of the analytical solution techniques used in this program, the responsibilities for modeling the structure, inputting data, applying engineering judgment to evaluate the output, and implementing engineering drawings remain with the structural engineer of record. Accordingly, StructurePoint does and must disclaim any and all responsibility for defects or failures of structures in connection with which this program is used.

Neither this manual nor any part of it may be reproduced, edited, transmitted by any means by any means electronic or mechanical or by any information storage and retrieval system, without the written permission of STRUCTUREPOINT, LLC.

All products, corporate names, trademarks, service marks, and trade names referenced in this material are the property of their respective owners and are used only for identification explanation without intent to infringe. spColumn™ is a trademark of STRUCTUREPOINT, LLC.

Copyright © 2002 – 2009, STRUCTUREPOINT, LLC. All Rights Reserved.

Table of Contents

Chapter 1 – Introduction.....	1-1
Program Features.....	1-1
Program Capacity.....	1-2
System Requirements.....	1-2
Terms.....	1-2
Conventions.....	1-3
Installing, Purchasing and Licensing spColumn.....	1-3
Chapter 2 – Method of Solution.....	2-1
A – Definitions and Assumptions.....	2-1
B – Sign Convention.....	2-6
C – Section Investigation.....	2-8
D – Section Design.....	2-12
E – Moment Magnification for Nonsway Columns.....	2-13
F – Moment Magnification for Sway Columns.....	2-16
References.....	2-19
Chapter 3 – spColumn Interface.....	3-1
Main Window.....	3-1
File Menu.....	3-3
Input Menu.....	3-4
Solve Menu.....	3-6
View Menu.....	3-6
Options.....	3-8
Help Menu.....	3-9
Chapter 4 – Operating the Program.....	4-1
Creating a New Data File.....	4-1
Opening an Existing Data File.....	4-1
Saving the Data.....	4-2
Importing Data.....	4-3
Exporting Data.....	4-4
Printing the Results.....	4-5
General Information.....	4-6
Material Properties.....	4-7
Section / Rectangular.....	4-7

Section / Circular	4-8
Reinforcement / All Sides Equal.....	4-9
Reinforcement / Equal Spacing.....	4-10
Reinforcement / Sides Different.....	4-11
Reinforcement / Irregular Pattern.....	4-12
Reinforcement / Confinement.....	4-13
Reinforcement / Design Criteria	4-13
Slenderness / Factors.....	4-14
Slenderness / Design Column	4-15
Slenderness / Columns Above and Below	4-16
Slenderness / X-Beams	4-16
Slenderness / Y-Beams	4-17
Loads / Factored.....	4-18
Loads / Service.....	4-19
Load / Control Points.....	4-20
Loads / Axial Loads	4-20
Loads / Load Combinations	4-21
Flipping / Rotating the Section	4-22
Executing a Run.....	4-22
Viewing the Results	4-24
Changing the Reinforcement Bar Set.....	4-25
Superimposing Diagrams	4-26
Viewing the Diagram.....	4-26
Viewing the Contour.....	4-27
Chapter 5 – Examples	5-1
Example 1 – Capacity of a Square Column	5-1
Example 2 – Investigation of a slender Non-Sway Column	5-6
Example 3 – Design of a Slender Column in a Sway Frame	5-15
Chapter 6 – spSection Module	5-22
Main Menu.....	6-2
Edit Menu.....	6-2
View Menu.....	6-3
Help Menu	6-3
Defining the Drawing Area.....	6-4
Graphical Editing of the Section or Opening.....	6-4
Graphical Editing of the Reinforcement	6-6
Manual Editing of the Section or Opening.....	6-8
Manual Editing of the Reinforcement.....	6-8
Zooming and Panning the Image	6-9
Example 4 – Capacity of an Irregular Section	6-10

Appendix	A-1
Import File Formats	A-1
spColumn Text Input (CTI) file format	A-3
Conversion Factors - English to SI	A-17
Conversion Factors - SI to English	A-17
Contact Information	A-18

License Agreements

STRUCTUREPOINT EVALUATION SOFTWARE LICENSE AGREEMENT

BY CLICKING THE "I AGREE" ICON BELOW, OR BY INSTALLING, COPYING, OR OTHERWISE USING THE SOFTWARE OR USER DOCUMENTATION, YOU AGREE TO BE BOUND BY THE TERMS OF THIS AGREEMENT, INCLUDING, BUT NOT LIMITED TO, THE WARRANTY DISCLAIMERS, LIMITATIONS OF LIABILITY AND TERMINATION PROVISIONS BELOW. IF YOU DO NOT AGREE TO THE TERMS OF THIS AGREEMENT, DO NOT INSTALL OR USE THE SOFTWARE OR USER DOCUMENTATION, EXIT THIS APPLICATION NOW AND RETURN THE SOFTWARE AND USER DOCUMENTATION TO STRUCTUREPOINT.

STRUCTUREPOINT, 5420 OLD ORCHARD ROAD, SKOKIE, ILLINOIS 60077, GRANTS THE CUSTOMER A PERSONAL, NONEXCLUSIVE, LIMITED, NONTRANSFERABLE LICENSE TO USE THIS SOFTWARE AND USER DOCUMENTATION SOLELY FOR TRIAL AND EVALUATION PURPOSES ONLY IN ACCORDANCE WITH THE TERMS AND CONDITIONS OF THIS AGREEMENT. SOFTWARE AND USER DOCUMENTATION IS SUPPLIED TO CUSTOMER EITHER BY STRUCTUREPOINT DIRECTLY OR THROUGH AN AUTHORIZED DEALER OF STRUCTUREPOINT (HEREAFTER DEALER).

WHILE STRUCTUREPOINT HAS TAKEN PRECAUTIONS TO ASSURE THE CORRECTNESS OF THE ANALYTICAL SOLUTION AND DESIGN TECHNIQUES USED IN THIS SOFTWARE, IT CANNOT AND DOES NOT GUARANTEE ITS PERFORMANCE, NOR CAN IT OR DOES IT BEAR ANY RESPONSIBILITY FOR DEFECTS OR FAILURES IN STRUCTURES IN CONNECTION WITH WHICH THIS SOFTWARE MAY BE USED. DEALER (IF ANY) HAS NOT PARTICIPATED IN THE DESIGN OR DEVELOPMENT OF THIS SOFTWARE AND NEITHER GUARANTEES THE PERFORMANCE OF THE SOFTWARE NOR BEARS ANY RESPONSIBILITY FOR DEFECTS OR FAILURES IN STRUCTURES IN CONNECTION WITH WHICH THIS SOFTWARE IS USED.

STRUCTUREPOINT AND DEALER (IF ANY) EXPRESSLY DISCLAIM ANY WARRANTY THAT: (A) THE FUNCTIONS CONTAINED IN THE SOFTWARE WILL MEET THE REQUIREMENTS OF CUSTOMER OR OPERATE IN COMBINATIONS THAT MAY BE SELECTED FOR USE BY CUSTOMER; (B) THE OPERATION OF THE SOFTWARE WILL BE FREE OF ALL "BUGS" OR PROGRAM ERRORS; OR (C) THE SOFTWARE CONFORMS TO ANY PERFORMANCE SPECIFICATIONS. CUSTOMER ACKNOWLEDGES THAT STRUCTUREPOINT IS UNDER NO OBLIGATION TO PROVIDE ANY SUPPORT, UPDATES, BUG FIXES OR ERROR CORRECTIONS TO OR FOR THE SOFTWARE OR USER DOCUMENTATION.

THE LIMITED WARRANTIES IN SECTION 6 HEREOF ARE IN LIEU OF ALL OTHER WARRANTIES, EXPRESS OR IMPLIED, INCLUDING, BUT NOT LIMITED TO, ANY IMPLIED WARRANTIES OF NON-INFRINGEMENT, MERCHANTABILITY OR FITNESS FOR A PARTICULAR PURPOSE, EACH OF WHICH IS HEREBY DISCLAIMED. EXCEPT AS SET FORTH IN SECTION 6, THE SOFTWARE AND USER DOCUMENTATION ARE PROVIDED ON AN "AS-IS" BASIS.

IN NO EVENT SHALL STRUCTUREPOINT OR DEALER (IF ANY) BE LIABLE FOR: (A) LOSS OF PROFITS, DIRECT, INDIRECT, INCIDENTAL, SPECIAL, EXEMPLARY, PUNITIVE, CONSEQUENTIAL OR OTHER DAMAGES, EVEN IF STRUCTUREPOINT OR DEALER (IF

ANY) HAS BEEN ADVISED OF THE POSSIBILITY OF SUCH DAMAGES; (B) ANY CLAIM AGAINST CUSTOMER BY ANY THIRD PARTY; OR (C) ANY DAMAGES CAUSED BY (1) DELAY IN DELIVERY OF THE SOFTWARE OR USER DOCUMENTATION UNDER THIS AGREEMENT; (2) THE PERFORMANCE OR NON PERFORMANCE OF THE SOFTWARE; (3) RESULTS FROM USE OF THE SOFTWARE OR USER DOCUMENTATION, INCLUDING, WITHOUT LIMITATION, MISTAKES, ERRORS, INACCURACIES, FAILURES OR CUSTOMER'S INABILITY TO PROVIDE SERVICES TO THIRD PARTIES THROUGH USE OF THE SOFTWARE OR USER DOCUMENTATION; (4) CUSTOMER'S FAILURE TO PERFORM CUSTOMER'S RESPONSIBILITIES; (5) STRUCTUREPOINT NOT PROVIDING UPDATES, BUG FIXES OR CORRECTIONS TO OR FOR ANY OF THE SOFTWARE OR USER DOCUMENTATION; (6) LABOR, EXPENSE OR MATERIALS NECESSARY TO REPAIR DAMAGE TO THE SOFTWARE OR USER DOCUMENTATION CAUSED BY (a) ACCIDENT, (b) NEGLIGENCE OR ABUSE BY CUSTOMER, (c) ACTS OF THIRD PERSONS INCLUDING, BUT NOT LIMITED TO, INSTALLATION, REPAIR, MAINTENANCE OR OTHER CORRECTIVE WORK RELATED TO ANY EQUIPMENT BEING USED, (d) CAUSES EXTERNAL TO THE SOFTWARE SUCH AS POWER FLUCTUATION AND FAILURES, OR (e) FLOODS, WINDSTORMS OR OTHER ACTS OF GOD. MOREOVER, IN NO EVENT SHALL STRUCTUREPOINT BE LIABLE FOR WARRANTIES, GUARANTEES, REPRESENTATIONS OR ANY OTHER UNDERSTANDINGS BETWEEN CUSTOMER AND DEALER (IF ANY) RELATING TO THE SOFTWARE OR USER DOCUMENTATION.

THIS AGREEMENT CONSTITUTES THE ENTIRE AND EXCLUSIVE AGREEMENT BETWEEN CUSTOMER AND STRUCTUREPOINT AND DEALER (IF ANY) WITH RESPECT TO THE SOFTWARE AND USER DOCUMENTATION TO BE FURNISHED HEREUNDER. IT IS A FINAL EXPRESSION OF THAT AGREEMENT AND UNDERSTANDING. IT SUPERSEDES ALL PRIOR COMMUNICATIONS BETWEEN THE PARTIES (INCLUDING ANY EVALUATION LICENSE AND ALL ORAL AND WRITTEN PROPOSALS). ORAL STATEMENTS MADE BY STRUCTUREPOINT'S OR DEALER'S (IF ANY) REPRESENTATIVES ABOUT THE SOFTWARE OR USER DOCUMENTATION DO NOT CONSTITUTE REPRESENTATIONS OR WARRANTIES, SHALL NOT BE RELIED ON BY CUSTOMER, AND ARE NOT PART OF THIS AGREEMENT.

1. LICENSE RESTRICTIONS

- a. Except as expressly provided in this Agreement or as otherwise authorized in writing by STRUCTUREPOINT, Customer has no right to: (1) use, print, copy, display, reverse assemble, reverse engineer, translate or decompile the Software or User Documentation in whole or in part; (2) disclose, publish, release, sublicense or transfer to another person any Software or User Documentation; (3) reproduce the Software or User Documentation for the use or benefit of anyone other than Customer; or (4) modify any Software or User Documentation. All rights to the Software and User Documentation not expressly granted to Customer hereunder are retained by STRUCTUREPOINT. All copyrights and other proprietary rights except as expressed elsewhere in the Software or User Documentation and legal title thereto shall remain in STRUCTUREPOINT. Customer may use the Software only as licensed by STRUCTUREPOINT on designated workstation at Customer's site at any given time. Customer may not transmit the Software licenses electronically to any other workstation, computer, node or terminal device whether via a local area network, a wide area network, telecommunications transmission, the Internet or other means now known or hereafter created without prior written permission by STRUCTUREPOINT.
- b. Customer acknowledges that this is a limited license for trial and evaluation purposes only. This limited license shall automatically terminate upon the earlier of: (1) ten executions of

the Software on the computer on which it is installed; or (2) fifteen days after the installation of the Software. Thereafter, Customer may only use the Software and Documentation if it acquires a production license for the same.

2. TERM AND TERMINATION

- c. This Agreement shall be in effect from the date Customer clicks the “I AGREE” icon below or installs, copies or otherwise uses the Software or User Documentation until: (1) it is terminated by Customer, by Dealer (if any) on behalf of Customer or STRUCTUREPOINT or by STRUCTUREPOINT as set forth herein; or (2) the limited trial and evaluation license terminates.
- d. This Agreement may be terminated by STRUCTUREPOINT without cause upon 30 days' written notice or immediately upon notice to Customer if Customer breaches this Agreement or fails to comply with any of its terms or conditions. This Agreement may be terminated by Customer without cause at any time upon written notice to STRUCTUREPOINT.

3. BACKUP AND REPLACEMENT COPIES

Customer may make one copy of the Software for back-up and archival purposes only, provided STRUCTUREPOINT's copyright and other proprietary rights notices are included on such copy.

4. PROTECTION AND SECURITY

- a. Customer shall not provide or otherwise make available any of the Software or User Documentation in any form to any person other than employees of Customer with the need to know, without STRUCTUREPOINT's written permission.
- b. All Software and User Documentation in Customer's possession including, without limitation, translations, compilations, back-up, and partial copies is the property of STRUCTUREPOINT. Upon termination of this Agreement for any reason, Customer shall immediately destroy all Software and User Documentation, including all media, and destroy any Software that has been copied onto other magnetic storage devices. Upon STRUCTUREPOINT's request, Customer shall certify its compliance in writing with the foregoing to STRUCTUREPOINT.
- c. Customer shall take appropriate action, by instruction, agreement or otherwise, with any persons permitted access to the Software or User Documentation, to enable Customer to satisfy its obligations under this Agreement with respect to use, copying, protection, and security of the same.
- d. If STRUCTUREPOINT prevails in an action against Customer for breach of the provisions of this Section 4, Customer shall pay the reasonable attorneys' fees, costs, and expenses incurred by STRUCTUREPOINT in connection with such action in addition to any award of damages.

5. CUSTOMER'S RESPONSIBILITIES

The essential purpose of this Agreement is to provide Customer with limited use rights to the Software and User Documentation. Customer accepts full responsibility for: (a) selection of the Software and User Documentation to satisfy Customer's business needs and achieve Customer's intended results; (b) the use, set-up and installation of the Software and User Documentation; (c) all results obtained from use of the Software and User Documentation; and (d) the selection,

use of, and results obtained from any other software, programming equipment or services used with the Software or User Documentation.

6. LIMITED WARRANTIES

STRUCTUREPOINT and Dealer (if any) warrants to Customer that: (a) STRUCTUREPOINT and Dealer (if any) has title to the Software and User Documentation and/or the right to grant Customer the rights granted hereunder; (b) the Software and User Documentation provided hereunder is STRUCTUREPOINT's most current production version thereof; and (c) the copy of the Software provided hereunder is an accurate reproduction of the original from which it was made.

7. LIMITATION OF REMEDY

- a. **STRUCTUREPOINT AND DEALER (IF ANY) HAS NO LIABILITY UNDER THIS AGREEMENT. CUSTOMER'S EXCLUSIVE REMEDY FOR DAMAGES DUE TO PERFORMANCE OR NONPERFORMANCE OF ANY SOFTWARE OR USER DOCUMENTATION, STRUCTUREPOINT, DEALER (IF ANY), OR ANY OTHER CAUSE WHATSOEVER, AND REGARDLESS OF THE FORM OF ACTION, WHETHER IN CONTRACT OR IN TORT, INCLUDING NEGLIGENCE, SHALL BE LIMITED TO CUSTOMER STOPPING ALL USE OF THE SOFTWARE AND USER DOCUMENTATION AND RETURNING THE SAME TO STRUCTUREPOINT.**
- b. **NEITHER STRUCTUREPOINT NOR DEALER (IF ANY) IS AN INSURER WITH REGARD TO THE PERFORMANCE OF THE SOFTWARE OR USER DOCUMENTATION. THE TERMS OF THIS AGREEMENT, INCLUDING, BUT NOT LIMITED TO, THE LIMITED WARRANTIES, AND THE LIMITATION OF LIABILITY AND REMEDY, ARE A REFLECTION OF THE RISKS ASSUMED BY THE PARTIES. IN ORDER TO OBTAIN THE SOFTWARE AND USER DOCUMENTATION FROM STRUCTUREPOINT OR DEALER (IF ANY), CUSTOMER HEREBY ASSUMES THE RISKS FOR (1) ALL LIABILITIES DISCLAIMED BY STRUCTUREPOINT AND DEALER (IF ANY) ON THE FACE HEREOF; AND (2) ALL ACTUAL OR ALLEGED DAMAGES IN CONNECTION WITH THE USE OF THE SOFTWARE AND USER DOCUMENTATION. THE ESSENTIAL PURPOSE OF THE LIMITED REMEDY PROVIDED CUSTOMER HEREUNDER IS TO ALLOCATE THE RISKS AS PROVIDED ABOVE.**

8. U.S. GOVERNMENT RESTRICTED RIGHTS

This commercial computer software and commercial computer software documentation were developed exclusively at private expense by STRUCTUREPOINT, 5420 Old Orchard Road, Skokie, Illinois, 60077. U.S. Government rights to use, modify, release, reproduce, perform, display or disclose this computer software and computer software documentation are subject to the restrictions of DFARS 227.7202-1(a) (September 2007) and DFARS 227.7202-3(a) (September 2007), or the Restricted Rights provisions of FAR 52.227-14 (December 2007) and FAR 52.227-19 (December 2007), as applicable.

9. GENERAL

- a. No action arising out of any claimed breach of this Agreement or transactions under this Agreement may be brought by Customer more than two years after the cause of such action has arisen.

- b. Customer may not assign, sell, sublicense or otherwise transfer this Agreement, the license granted herein or the Software or User Documentation by operation of law or otherwise without the prior written consent of STRUCTUREPOINT. Any attempt to do any of the foregoing without STRUCTUREPOINT's consent is void.
- c. Customer acknowledges that the Software, User Documentation and other proprietary information and materials of STRUCTUREPOINT are unique and that, if Customer breaches this Agreement, STRUCTUREPOINT may not have an adequate remedy at law and STRUCTUREPOINT may enforce its rights hereunder by an action for damages and/or injunctive or other equitable relief without the necessity of proving actual damage or posting a bond therefor.
- d. THE RIGHTS AND OBLIGATIONS UNDER THIS AGREEMENT SHALL NOT BE GOVERNED BY THE UNITED NATIONS CONVENTION ON CONTRACTS FOR THE INTERNATIONAL SALE OF GOODS, THE APPLICATION OF WHICH IS EXPRESSLY EXCLUDED, BUT SUCH RIGHTS AND OBLIGATIONS SHALL INSTEAD BE GOVERNED BY THE LAWS OF THE STATE OF ILLINOIS, APPLICABLE TO CONTRACTS ENTERED INTO AND PERFORMED ENTIRELY WITHIN THE STATE OF ILLINOIS AND APPLICABLE FEDERAL (U.S.) LAWS. UCITA SHALL NOT APPLY TO THIS AGREEMENT.
- e. THIS AGREEMENT SHALL BE TREATED AS THOUGH IT WERE EXECUTED IN THE COUNTY OF COOK, STATE OF ILLINOIS, AND WAS TO HAVE BEEN PERFORMED IN THE COUNTY OF COOK, STATE OF ILLINOIS. ANY ACTION RELATING TO THIS AGREEMENT SHALL BE INSTITUTED AND PROSECUTED IN A COURT LOCATED IN COOK COUNTY, ILLINOIS. CUSTOMER SPECIFICALLY CONSENTS TO EXTRATERRITORIAL SERVICE OF PROCESS.
- f. Except as prohibited elsewhere in this Agreement, this Agreement shall be binding upon and inure to the benefit of the personal and legal representatives, permitted successors, and permitted assigns of the parties hereto.
- g. All notices, demands, consents or requests that may be or are required to be given by any party to another party shall be in writing. All notices, demands, consents or requests given by the parties hereto shall be sent either by U.S. certified mail, postage prepaid or by an overnight international delivery service, addressed to the respective parties. Notices, demands, consents or requests served as set forth herein shall be deemed sufficiently served or given at the time of receipt thereof.
- h. The various rights, options, elections, powers, and remedies of a party or parties to this Agreement shall be construed as cumulative and no one of them exclusive of any others or of any other legal or equitable remedy that said party or parties might otherwise have in the event of breach or default in the terms hereof. The exercise of one right or remedy by a party or parties shall not in any way impair its rights to any other right or remedy until all obligations imposed on a party or parties have been fully performed.
- i. No waiver by Customer, STRUCTUREPOINT or Dealer (if any) of any breach, provision, or default by the other shall be deemed a waiver of any other breach, provision or default.
- j. The parties hereto, and each of them, agree that the terms of this Agreement shall be given a neutral interpretation and any ambiguity or uncertainty herein should not be construed against any party hereto.

- k. If any provision of this Agreement or portion thereof is held to be unenforceable or invalid by any court or competent jurisdiction, such decision shall not have the effect of invalidating or voiding the remainder of this Agreement, it being the intent and agreement of the parties that this Agreement shall be deemed amended by modifying such provision to the extent necessary to render it enforceable and valid while preserving its intent or, if such modification is not possible, by substituting therefor another provision that is enforceable and valid so as to materially effectuate the parties' intent.

Except as set forth herein, this Agreement may be modified or amended only by a written instrument signed by a duly authorized representative of STRUCTUREPOINT and Customer.

STRUCTUREPOINT SOFTWARE LICENSE AGREEMENT

BY CLICKING THE “I AGREE” BELOW, OR BY INSTALLING, COPYING, OR OTHERWISE USING THE SOFTWARE OR USER DOCUMENTATION, YOU AGREE TO BE BOUND BY THE TERMS OF THIS AGREEMENT, INCLUDING, BUT NOT LIMITED TO, THE WARRANTY DISCLAIMERS, LIMITATIONS OF LIABILITY AND TERMINATION PROVISIONS BELOW. IF YOU DO NOT AGREE TO THE TERMS OF THIS AGREEMENT, DO NOT INSTALL OR USE THE SOFTWARE OR USER DOCUMENTATION, EXIT THIS APPLICATION NOW AND RETURN THE SOFTWARE AND USER DOCUMENTATION TO STRUCTUREPOINT FOR A FULL REFUND WITHIN THIRTY DAYS AFTER YOUR RECEIPT OF THE SOFTWARE AND USER DOCUMENTATION.

STRUCTUREPOINT, 5420 OLD ORCHARD ROAD, SKOKIE, ILLINOIS 60077, GRANTS THE CUSTOMER A PERSONAL, NONEXCLUSIVE, LIMITED, NONTRANSFERABLE LICENSE TO USE THIS SOFTWARE AND USER DOCUMENTATION IN ACCORDANCE WITH THE TERMS AND CONDITIONS OF THIS AGREEMENT. SOFTWARE AND USER DOCUMENTATION IS SUPPLIED TO CUSTOMER EITHER BY STRUCTUREPOINT DIRECTLY OR THROUGH AN AUTHORIZED DEALER OF STRUCTUREPOINT (HEREAFTER DEALER).

WHILE STRUCTUREPOINT HAS TAKEN PRECAUTIONS TO ASSURE THE CORRECTNESS OF THE ANALYTICAL SOLUTION AND DESIGN TECHNIQUES USED IN THIS SOFTWARE, IT CANNOT AND DOES NOT GUARANTEE ITS PERFORMANCE, NOR CAN IT OR DOES IT BEAR ANY RESPONSIBILITY FOR DEFECTS OR FAILURES IN STRUCTURES IN CONNECTION WITH WHICH THIS SOFTWARE IS USED. DEALER (IF ANY) HAS NOT PARTICIPATED IN THE DESIGN OR DEVELOPMENT OF THIS SOFTWARE AND NEITHER GUARANTEES THE PERFORMANCE OF THE SOFTWARE NOR BEARS ANY RESPONSIBILITY FOR DEFECTS OR FAILURES IN STRUCTURES IN CONNECTION WITH WHICH THIS SOFTWARE IS USED.

STRUCTUREPOINT AND DEALER (IF ANY) EXPRESSLY DISCLAIM ANY WARRANTY THAT: (A) THE FUNCTIONS CONTAINED IN THE SOFTWARE WILL MEET THE REQUIREMENTS OF CUSTOMER OR OPERATE IN COMBINATIONS THAT MAY BE SELECTED FOR USE BY CUSTOMER; (B) THE OPERATION OF THE SOFTWARE WILL BE FREE OF ALL "BUGS" OR PROGRAM ERRORS; OR (C) THE SOFTWARE CONFORMS TO ANY PERFORMANCE SPECIFICATIONS. CUSTOMER ACKNOWLEDGES THAT STRUCTUREPOINT IS UNDER NO OBLIGATION TO PROVIDE ANY SUPPORT, UPDATES, BUG FIXES OR ERROR CORRECTIONS TO OR FOR THE SOFTWARE OR USER DOCUMENTATION.

THE LIMITED WARRANTIES IN SECTION 7 HEREOF ARE IN LIEU OF ALL OTHER WARRANTIES, EXPRESS OR IMPLIED, INCLUDING, BUT NOT LIMITED TO, ANY IMPLIED WARRANTIES OF NON-INFRINGEMENT, MERCHANTABILITY OR FITNESS FOR A PARTICULAR PURPOSE, EACH OF WHICH IS HEREBY DISCLAIMED. EXCEPT AS SET FORTH IN SECTION 7, THE SOFTWARE AND USER DOCUMENTATION ARE PROVIDED ON AN "AS-IS" BASIS.

IN NO EVENT SHALL STRUCTUREPOINT OR DEALER (IF ANY) BE LIABLE FOR: (A) LOSS OF PROFITS, INDIRECT, INCIDENTAL, SPECIAL, EXEMPLARY, PUNITIVE, CONSEQUENTIAL OR OTHER DAMAGES, EVEN IF STRUCTUREPOINT OR DEALER (IF ANY) HAS BEEN ADVISED OF THE POSSIBILITY OF SUCH DAMAGES; (B) ANY CLAIM AGAINST CUSTOMER BY ANY THIRD PARTY EXCEPT AS PROVIDED IN SECTION 8 ENTITLED "INFRINGEMENT"; OR (C) ANY DAMAGES CAUSED BY (1) DELAY IN

DELIVERY OF THE SOFTWARE OR USER DOCUMENTATION UNDER THIS AGREEMENT; (2) THE PERFORMANCE OR NONPERFORMANCE OF THE SOFTWARE; (3) RESULTS FROM USE OF THE SOFTWARE OR USER DOCUMENTATION, INCLUDING, WITHOUT LIMITATION, MISTAKES, ERRORS, INACCURACIES, FAILURES OR CUSTOMER'S INABILITY TO PROVIDE SERVICES TO THIRD PARTIES THROUGH USE OF THE SOFTWARE OR USER DOCUMENTATION; (4) CUSTOMER'S FAILURE TO PERFORM CUSTOMER'S RESPONSIBILITIES; (5) STRUCTUREPOINT NOT PROVIDING UPDATES, BUG FIXES OR CORRECTIONS TO OR FOR ANY OF THE SOFTWARE OR USER DOCUMENTATION; (6) LABOR, EXPENSE OR MATERIALS NECESSARY TO REPAIR DAMAGE TO THE SOFTWARE OR USER DOCUMENTATION CAUSED BY (a) ACCIDENT, (b) NEGLIGENCE OR ABUSE BY CUSTOMER, (c) ACTS OF THIRD PERSONS INCLUDING, BUT NOT LIMITED TO, INSTALLATION, REPAIR, MAINTENANCE OR OTHER CORRECTIVE WORK RELATED TO ANY EQUIPMENT BEING USED, (d) CAUSES EXTERNAL TO THE SOFTWARE SUCH AS POWER FLUCTUATION AND FAILURES, OR (e) FLOODS, WINDSTORMS OR OTHER ACTS OF GOD. MOREOVER, IN NO EVENT SHALL STRUCTUREPOINT BE LIABLE FOR WARRANTIES, GUARANTEES, REPRESENTATIONS OR ANY OTHER UNDERSTANDINGS BETWEEN CUSTOMER AND DEALER (IF ANY) RELATING TO THE SOFTWARE OR USER DOCUMENTATION.

THIS AGREEMENT CONSTITUTES THE ENTIRE AND EXCLUSIVE AGREEMENT BETWEEN CUSTOMER AND STRUCTUREPOINT AND DEALER (IF ANY) WITH RESPECT TO THE SOFTWARE AND USER DOCUMENTATION TO BE FURNISHED HEREUNDER. IT IS A FINAL EXPRESSION OF THAT AGREEMENT AND UNDERSTANDING. IT SUPERSEDES ALL PRIOR COMMUNICATIONS BETWEEN THE PARTIES (INCLUDING ANY EVALUATION LICENSE AND ALL ORAL AND WRITTEN PROPOSALS). ORAL STATEMENTS MADE BY STRUCTUREPOINT 'S OR DEALER'S (IF ANY) REPRESENTATIVES ABOUT THE SOFTWARE OR USER DOCUMENTATION DO NOT CONSTITUTE REPRESENTATIONS OR WARRANTIES, SHALL NOT BE RELIED ON BY CUSTOMER, AND ARE NOT PART OF THIS AGREEMENT.

1. LICENSE RESTRICTIONS

- a. Except as expressly provided in this Agreement or as otherwise authorized in writing by STRUCTUREPOINT, Customer has no right to: (1) use, print, copy, display, reverse assemble, reverse engineer, translate or decompile the Software or User Documentation in whole or in part; (2) disclose, publish, release, sublicense or transfer to another person any Software or User Documentation; (3) reproduce the Software or User Documentation for the use or benefit of anyone other than Customer; or (4) modify any Software or User Documentation. All rights to the Software and User Documentation not expressly granted to Customer hereunder are retained by STRUCTUREPOINT. All copyrights and other proprietary rights except as expressed elsewhere in the Software or User Documentation and legal title thereto shall remain in STRUCTUREPOINT. Customer may use the Software only as licensed by STRUCTUREPOINT on designated workstation at Customer's site at any given time. Customer may not transmit the Software licenses electronically to any other workstation, computer, node or terminal device whether via a local area network, a wide area network, telecommunications transmission, the Internet or other means now known or hereafter created without prior written permission by STRUCTUREPOINT.
- b. Customer acknowledges that the registration process for the Software results in the generation of a unique license code. Once the license code is entered DURING THE INSTALLATION PROCESS, the Software will only work on the computer on which the Software LICENSE is INITIALLY installed. If you need to deinstall the Software license

and reinstall the Software license on a different computer, you must contact STRUCTUREPOINT to obtain the necessary reinstallation procedures.

2. CHARGES AND PAYMENTS

All payments for the Software and User Documentation shall be made to either STRUCTUREPOINT or Dealer (if any), as appropriate.

3. TERM AND TERMINATION

a. This Agreement shall be in effect from the date Customer clicks the “I AGREE” below or installs, copies or otherwise uses the Software or User Documentation until it is terminated by Customer, by Dealer (if any) on behalf of Customer or STRUCTUREPOINT or by STRUCTUREPOINT as set forth herein.

b. This Agreement may be terminated by STRUCTUREPOINT without cause upon 30 days' written notice or immediately upon notice to Customer if Customer breaches this Agreement or fails to comply with any of its terms or conditions. This Agreement may be terminated by Customer without cause at any time upon written notice to STRUCTUREPOINT.

4. BACKUP AND REPLACEMENT COPIES

Customer may make one copy of the Software for back-up and archival purposes only, provided STRUCTUREPOINT's copyright and other proprietary rights notices are included on such copy.

5. PROTECTION AND SECURITY

a. Customer shall not provide or otherwise make available any of the Software or User Documentation in any form to any person other than employees of Customer with the need to know, without STRUCTUREPOINT's written permission.

b. All Software and User Documentation in Customer's possession including, without limitation, translations, compilations, back-up, and partial copies is the property of STRUCTUREPOINT. Upon termination of this Agreement for any reason, Customer shall immediately destroy all Software and User Documentation, including all media, and destroy any Software that has been copied onto other magnetic storage devices. Upon STRUCTUREPOINT's request, Customer shall certify its compliance in writing with the foregoing to STRUCTUREPOINT.

c. Customer shall take appropriate action, by instruction, agreement or otherwise, with any persons permitted access to the Software or User Documentation, to enable Customer to satisfy its obligations under this Agreement with respect to use, copying, protection, and security of the same.

d. If STRUCTUREPOINT prevails in an action against Customer for breach of the provisions of this Section 5, Customer shall pay the reasonable attorneys' fees, costs, and expenses incurred by STRUCTUREPOINT in connection with such action in addition to any award of damages.

6. CUSTOMER'S RESPONSIBILITIES

The essential purpose of this Agreement is to provide Customer with limited use rights to the Software and User Documentation. Customer accepts full responsibility for: (a) selection of the Software and User Documentation to satisfy Customer's business needs and achieve Customer's intended results; (b) the use, set-up and installation of the Software and User Documentation; (c) all results obtained from use of the Software and User Documentation; and (d) the selection, use

of, and results obtained from any other software, programming equipment or services used with the Software or User Documentation.

7. LIMITED WARRANTIES

STRUCTUREPOINT and Dealer (if any) warrants to Customer that: (a) STRUCTUREPOINT and Dealer (if any) has title to the Software and User Documentation and/or the right to grant Customer the rights granted hereunder; (b) the Software and User Documentation provided hereunder is STRUCTUREPOINT's most current production version thereof; and (c) the copy of the Software provided hereunder is an accurate reproduction of the original from which it was made.

8. INFRINGEMENT

a. STRUCTUREPOINT shall defend Customer against a claim that the Software or User Documentation furnished and used within the scope of the license granted hereunder infringes a U.S. patent or U.S. registered copyright of any third party that was issued or registered, as applicable, as of the date Customer clicked the "I AGREE" below or installed, copied or otherwise began using the Software or User Documentation, and STRUCTUREPOINT shall pay resulting costs, damages, and attorneys' fees finally awarded, subject to the limitation of liability set forth in Section 9 entitled "Limitation of Remedy," provided that:

1. Customer promptly notifies STRUCTUREPOINT in writing of the claim.
2. STRUCTUREPOINT has sole control of the defense and all related settlement negotiations.

3. If such claim has occurred or in STRUCTUREPOINT's opinion is likely to occur, Customer shall permit STRUCTUREPOINT at its sole option and expense either to procure for Customer the right to continue using the Software or User Documentation or to replace or modify the same so that it becomes noninfringing. If neither of the foregoing alternatives is reasonably available in STRUCTUREPOINT's sole judgment, Customer shall, on one month's written notice from STRUCTUREPOINT, return to STRUCTUREPOINT the Software and User Documentation and all copies thereof.

b. STRUCTUREPOINT shall have no obligation to defend Customer or to pay costs, damages or attorneys' fees for any claim based upon (1) use of other than a current unaltered release of the Software or User Documentation, or (2) the combination, operation or use of any Software or User Documentation furnished hereunder with any other software, documentation or data if such infringement would have been avoided but for the combination, operation or use of the Software or User Documentation with other software, documentation or data.

c. The foregoing states the entire obligation of STRUCTUREPOINT and Customer's sole remedy with respect to infringement matters relating to the Software and User Documentation.

9. LIMITATION OF REMEDY

a. STRUCTUREPOINT'S AND DEALER'S (IF ANY) ENTIRE LIABILITY AND CUSTOMER'S EXCLUSIVE REMEDY FOR DAMAGES DUE TO PERFORMANCE OR NONPERFORMANCE OF ANY SOFTWARE OR USER DOCUMENTATION, STRUCTUREPOINT, DEALER (IF ANY), OR ANY OTHER CAUSE WHATSOEVER, AND REGARDLESS OF THE FORM OF ACTION, WHETHER IN CONTRACT OR IN TORT, INCLUDING NEGLIGENCE, SHALL BE LIMITED TO THE AMOUNT PAID

TO STRUCTUREPOINT OR DEALER (IF ANY) FOR THE SOFTWARE AND USER DOCUMENTATION.

- b. **NEITHER STRUCTUREPOINT NOR DEALER (IF ANY) IS AN INSURER WITH REGARD TO THE PERFORMANCE OF THE SOFTWARE OR USER DOCUMENTATION. THE TERMS OF THIS AGREEMENT, INCLUDING, BUT NOT LIMITED TO, THE LIMITED WARRANTIES, AND THE LIMITATION OF LIABILITY AND REMEDY, ARE A REFLECTION OF THE RISKS ASSUMED BY THE PARTIES. IN ORDER TO OBTAIN THE SOFTWARE AND USER DOCUMENTATION FROM STRUCTUREPOINT OR DEALER (IF ANY), CUSTOMER HEREBY ASSUMES THE RISKS FOR (1) ALL LIABILITIES DISCLAIMED BY STRUCTUREPOINT AND DEALER (IF ANY) ON THE FACE HEREOF; AND (2) ALL ACTUAL OR ALLEGED DAMAGES IN EXCESS OF THE AMOUNT OF THE LIMITED REMEDY PROVIDED HEREUNDER. THE ESSENTIAL PURPOSE OF THE LIMITED REMEDY PROVIDED CUSTOMER HEREUNDER IS TO ALLOCATE THE RISKS AS PROVIDED ABOVE.**

10. U.S. GOVERNMENT RESTRICTED RIGHTS

This commercial computer software and commercial computer software documentation were developed exclusively at private expense by STRUCTUREPOINT, 5420 Old Orchard Road, Skokie, Illinois 60077. U.S. Government rights to use, modify, release, reproduce, perform, display or disclose this computer software and computer software documentation are subject to the restrictions of DFARS 227.7202-1(a) (September 2007) and DFARS 227.7202-3(a) (September 2007), or the Restricted Rights provisions of FAR 52.227-14 (December 2007) and FAR 52.227-19 (December 2007), as applicable.

11. GENERAL

- a. No action arising out of any claimed breach of this Agreement or transactions under this Agreement may be brought by Customer more than two years after the cause of such action has arisen.
- b. Customer may not assign, sell, sublicense or otherwise transfer this Agreement, the license granted herein or the Software or User Documentation by operation of law or otherwise without the prior written consent of STRUCTUREPOINT. Any attempt to do any of the foregoing without STRUCTUREPOINT's consent is void.
- c. Customer acknowledges that the Software, User Documentation and other proprietary information and materials of STRUCTUREPOINT are unique and that, if Customer breaches this Agreement, STRUCTUREPOINT may not have an adequate remedy at law and STRUCTUREPOINT may enforce its rights hereunder by an action for damages and/or injunctive or other equitable relief without the necessity of proving actual damage or posting a bond therefor.
- d. THE RIGHTS AND OBLIGATIONS UNDER THIS AGREEMENT SHALL NOT BE GOVERNED BY THE UNITED NATIONS CONVENTION ON CONTRACTS FOR THE INTERNATIONAL SALE OF GOODS, THE APPLICATION OF WHICH IS EXPRESSLY EXCLUDED, BUT SUCH RIGHTS AND OBLIGATIONS SHALL INSTEAD BE GOVERNED BY THE LAWS OF THE STATE OF ILLINOIS, APPLICABLE TO CONTRACTS ENTERED INTO AND PERFORMED ENTIRELY WITHIN THE STATE OF ILLINOIS AND APPLICABLE FEDERAL (U.S.) LAWS. UCITA SHALL NOT APPLY TO THIS AGREEMENT.

- e. THIS AGREEMENT SHALL BE TREATED AS THOUGH IT WERE EXECUTED IN THE COUNTY OF COOK, STATE OF ILLINOIS, AND WAS TO HAVE BEEN PERFORMED IN THE COUNTY OF COOK, STATE OF ILLINOIS. ANY ACTION RELATING TO THIS AGREEMENT SHALL BE INSTITUTED AND PROSECUTED IN A COURT LOCATED IN COOK COUNTY, ILLINOIS. CUSTOMER SPECIFICALLY CONSENTS TO EXTRATERRITORIAL SERVICE OF PROCESS.
- f. Except as prohibited elsewhere in this Agreement, this Agreement shall be binding upon and inure to the benefit of the personal and legal representatives, permitted successors, and permitted assigns of the parties hereto.
- g. All notices, demands, consents or requests that may be or are required to be given by any party to another party shall be in writing. All notices, demands, consents or requests given by the parties hereto shall be sent either by U.S. certified mail, postage prepaid or by an overnight international delivery service, addressed to the respective parties. Notices, demands, consents or requests served as set forth herein shall be deemed sufficiently served or given at the time of receipt thereof.
- h. The various rights, options, elections, powers, and remedies of a party or parties to this Agreement shall be construed as cumulative and no one of them exclusive of any others or of any other legal or equitable remedy that said party or parties might otherwise have in the event of breach or default in the terms hereof. The exercise of one right or remedy by a party or parties shall not in any way impair its rights to any other right or remedy until all obligations imposed on a party or parties have been fully performed.
- i. No waiver by Customer, STRUCTUREPOINT or Dealer (if any) of any breach, provision, or default by the other shall be deemed a waiver of any other breach, provision or default.
- j. The parties hereto, and each of them, agree that the terms of this Agreement shall be given a neutral interpretation and any ambiguity or uncertainty herein should not be construed against any party hereto.
- k. If any provision of this Agreement or portion thereof is held to be unenforceable or invalid by any court or competent jurisdiction, such decision shall not have the effect of invalidating or voiding the remainder of this Agreement, it being the intent and agreement of the parties that this Agreement shall be deemed amended by modifying such provision to the extent necessary to render it enforceable and valid while preserving its intent or, if such modification is not possible, by substituting therefor another provision that is enforceable and valid so as to materially effectuate the parties' intent.

Except as set forth herein, this Agreement may be modified or amended only by a written instrument signed by a duly authorized representative of STRUCTUREPOINT and Customer.

April 2009

Chapter 1

Introduction

spColumn is a software program for the design and investigation of reinforced concrete sections subject to axial and flexural loads. The section can be rectangular, round or irregular, with any reinforcement layout or pattern. Slenderness effects can be considered.

The program offers investigation of irregularly shaped, reinforced concrete column sections that may contain openings or boundary elements. Widely used for design of shear walls, bridge piers as well as typical framing elements in buildings, spColumn can investigate sections that are impossible to find on design charts or do by hand calculations. You can obtain the P-M interaction diagrams from both uniaxial and biaxial runs, as well as the M_x - M_y moment contour plots from biaxial runs for even the most irregular column and shearwall sections. Slenderness effects producing magnified moments may be included in the investigation.

Program Features

- ACI 318-05, ACI 318-02, CSA A23.3-04, and CSA A23.3-94
- English and SI units
- Design and investigation run options
- Uniaxial or biaxial flexure combined with axial load
- Rectangular, circular, and irregular section geometry
- Non-slender and sway or non-sway slender columns
- Complete P-M and M_x - M_y interaction diagrams
- Customizable view of interaction diagrams
- Superposition of interaction diagram from a different run
- Factored, unfactored, axial, and control points loading
- Binary (COL) and text (CTI) input file formats

- Graphical input for irregular sections
- Imports geometry, reinforcement, and loads from text files
- Exports section to DXF files
- Exports P-M diagrams, M_x - M_y diagrams and 3D failure surface to TXT and CSV files
- GUI (Graphical User Interface) and batch (command prompt) mode runs
- Reports neutral axis location and maximum steel strain corresponding to section capacity
- Reports strength reduction factors in text output

Program Capacity

- 10,000 reinforcing bars within a section.
- 10,000 exterior points that define the geometric outline of the cross section (spSection module).
- 10,000 interior points that define an opening in the cross section (spSection module).
- 5,000 factored load entries, each consisting of an axial load, a moment about the x-axis, and a moment about the y-axis.
- 50 service load entries, each consisting of dead, live, wind, earthquake, and snow axial loads, moments at column top about the x and y axes, and moments at column bottom about the x and y axes.
- 50 load combinations.

System Requirements

Any computer running Microsoft Windows XP or Vista is sufficient to run spColumn program. Please refer to our [Software Quick Start Guide](#) for instructions on how to troubleshoot Vista related issues.

Terms

The following terms are used throughout this manual. A brief explanation is given to help familiarize you with them.

Windows	refers to the Microsoft Windows environment version 3.1 or higher.
[]	indicates metric equivalent
Click on	means to position the cursor on top of a designated item or location and press and release the left-mouse button (unless instructed to use the right-mouse button).
Double-click on	means to position the cursor on top of a designated item or location and press and release the left-mouse button twice in quick succession.

Conventions

To help you locate and interpret information easily, the spColumn manual adheres to the following text format.

<i>Italic</i>	indicates a glossary item, or emphasizes a given word or phrase.
Bold	indicates the name of a menu or a menu item command such as File or Save.
Mono-space	indicates something you should enter with the keyboard. For example “c:*.txt”.
KEY + KEY	indicates a key combination. The plus sign indicates that you should press and hold the first key while pressing the second key, then release both keys. For example, “ALT + F” indicates that you should press the “ALT” key and hold it while you press the “F” key. then release both keys.
SMALL CAPS	Indicates the name of an object such as a dialog box or a dialog box component. For example, the OPEN dialog box or the CANCEL or MODIFY buttons.

Installing, Purchasing and Licensing spColumn

For instructions on how to install, purchase and license StructurePoint software please refer to our [Software Quick Start Guide](#).

Chapter 2

Method of Solution

A – Definitions and Assumptions

1. The analysis of the reinforced concrete section performed by spColumn conforms to the provisions of the Strength Design Method¹ and Unified Design Provisions² and is based on the following assumptions.
 - a) All conditions of strength satisfy the applicable conditions of equilibrium and strain compatibility³
 - b) Strain in the concrete and in the reinforcement is directly proportional to the distance from the neutral axis⁴
 - c) The maximum usable (ultimate) strain at the extreme concrete compression fiber is assumed equal to 0.003 for ACI codes⁵ and 0.0035 for CSA codes⁶ unless otherwise specified by the user
 - d) A uniform rectangular concrete stress block is used. For ACI code⁷, the maximum uniform concrete compressive stress, f_c , is $0.85f'_c$ and the block depth is β_1c , where c is the distance from the extreme compression fiber to the neutral axis and β_1 is described in item 4 below. For CSA⁸, f_c is taken as:

$$f_c = (0.85 - 0.0015f'_c)f'_c \geq 0.67f'_c, \text{ where } f'_c \text{ is in MPa}$$

Both f_c and β_1 can be modified by the user.

¹ For the CSA A23.3-04 (Ref. [3]) and CSA A23.3-94 (Ref. [4])

² For ACI 318-05 (Ref. [1]) and ACI 318-02 (Ref. [2]); also see notes on 8.1.2 in Ref. [6]

³ ACI 318-05, 10.2.1; ACI 318-02, 10.2.1; CSA A23.3-04, 10.1.1; CSA A23.3-94, 10.1.1

⁴ ACI 318-05, 10.2.2; ACI 318-02, 10.2.2; CSA A23.3-04, 10.1.2; CSA A23.3-94, 10.1.2

⁵ ACI 318-05, 10.2.3; ACI 318-02, 10.2.3

⁶ CSA A23.3-04, 10.1.3; CSA A23.3-94, 10.1.3

⁷ ACI 318-05, 10.2.6, 10.2.7; ACI 318-02, 10.2.6, 10.2.6

⁸ ACI 318-05, 10.2.1; ACI 318-02, 10.2.1; CSA A23.3-04, 10.1.1; CSA A23.3-94, 10.1.1

- e) Concrete displaced by the reinforcement in compression is deducted from the compression block⁹

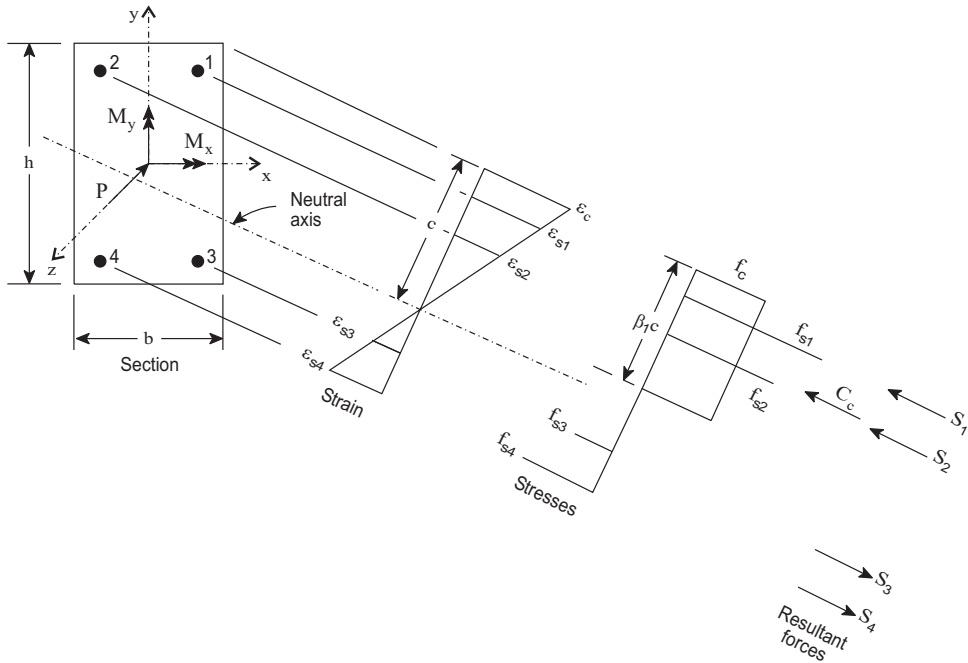

Figure 2-1 Analysis of Reinforced Section

- f) For the reinforcing steel, the elastic-plastic stress-strain distribution is used¹⁰. Stress in the reinforcing steel below the yield strength, f_y , is directly proportional to the strain. For strains greater than that corresponding to the yield strength, the reinforcement stress remains constant and equal to f_y .
- g) Tensile strength of concrete is neglected¹¹.
- h) Reinforcement bars are located within section outline.

⁹ For consistency with Eq. 10-1 and 10-2 in ACI codes (Refs. [1], [2]) and with Eq. 10-10 in CSA codes (Refs. [3], [4])

¹⁰ ACI 318-05, 10.2.4; ACI 318-02, 10.2.4; CSA A23.3-04, 8.5.3.2; CSA A23.3-94, 8.5.3.2

¹¹ ACI 318-05, 10.2.5; ACI 318-02, 10.2.5; CSA A23.3-04, 10.1.5; CSA A23.3-94, 10.1.5

- The modulus of elasticity of concrete, E_c , is computed as follows (unless otherwise specified by the user):

$$E_c = 57,000\sqrt{f'_c}, \text{ for the ACI code}^{12} \text{ where } f'_c \text{ and } E_c \text{ are in psi,}$$

$$E_c = 4,700\sqrt{f'_c}, \text{ for the ACI code}^{13} \text{ where } f'_c \text{ and } E_c \text{ are in MPa.}$$

For the CSA standard¹⁴, $E_c = 3,518\sqrt{f'_c} + 7,355$, where f'_c and E_c are in MPa.

- The modulus of elasticity of reinforcing steel¹⁵, E_s , is taken as 29,000 ksi (200,000 MPa) unless otherwise specified by the user.
- The ratio of the concrete compression block depth to the distance between the extreme compression fiber and the neutral axis, β_1 , is computed as follows (unless otherwise specified by the user):

$$0.65 \leq \beta_1 = 1.05 - 0.05f'_c \leq 0.85, \text{ for the ACI code}^{16} \text{ where } f'_c \text{ is in ksi,}$$

$$0.65 \leq \beta_1 = (149 - f'_c) / 140 \leq 0.85, \text{ for the ACI code}^{17} \text{ where } f'_c \text{ is in MPa.}$$

For the CSA standard¹⁸, $\beta_1 = 0.97 - 0.0025f'_c \geq 0.67$, where f'_c is in MPa.

- Stress in the reinforcement is computed based on the strain at the centroid of each reinforcing bar.
- All moments are referenced to the geometric centroid of the gross concrete section (neglecting the reinforcement).
- For the ACI codes, the nominal (unreduced) capacity of the section is first computed. Then, the nominal capacity is reduced to the design capacity using

¹² ACI 318-05, 8.5.1; ACI 318-02, 8.5.1

¹³ ACI 318M-05, 8.5.1; ACI 318M-02, 8.5.1

¹⁴ CSA A23.3-04, 8.6.2.3, Eq. 8.1 and CSA A23.3-94, 8.6.2.3, Eq. 8-6 (with $\gamma_c = 2400 \text{ kg/m}^3$)

¹⁵ ACI 318-05, 8.5.2; ACI 318-02, 8.5.2; ACI 318M-05, 8.5.2; ACI 318M-02, 8.5.2; CSA A23.3-04, 8.5.4.1; CSA A23.3-94, 8.5.4.1

¹⁶ ACI 318-05, 10.2.7.3; ACI 318-02, 10.2.7.3

¹⁷ ACI 318M-05, 10.2.7.3; ACI 318M-02, 10.2.7.3

¹⁸ CSA A23.3-04, 10.7.1(c); CSA A23.3-94, 10.7.1(c)

the strength reduction factor, ϕ , the value of which is calculated based on the net tensile steel strain, ε_t , in the following way¹⁹:

For columns with spiral reinforcement

$$\phi = \begin{cases} 0.9 & \text{if } \varepsilon_t \geq 0.005 \text{ (tension controlled section)} \\ 0.70 + \frac{0.20(\varepsilon_t - f_y/E_s)}{0.005 - f_y/E_s} & \text{if } f_y/E_y < \varepsilon_t < 0.005 \text{ (transition section)} \\ 0.70 & \text{if } \varepsilon_t \leq f_y/E_y \text{ (compression controlled section)} \end{cases}$$

For other columns

$$\phi = \begin{cases} 0.9 & \text{if } \varepsilon_t \geq 0.005 \text{ (tension controlled section)} \\ 0.65 + \frac{0.25(\varepsilon_t - f_y/E_s)}{0.005 - f_y/E_s} & \text{if } f_y/E_y < \varepsilon_t < 0.005 \text{ (transition section)} \\ 0.65 & \text{if } \varepsilon_t \leq f_y/E_y \text{ (compression controlled section)} \end{cases}$$

For the CSA standards, the program calculates the factored resistance directly using the factored compressive concrete strength²⁰, $\phi_c f'_c$, and the factored forces in reinforcement bars²¹, $\phi_s S_f$. The material resistance factor for concrete, ϕ_c , equals

$$\phi_c = \begin{cases} 0.6 & \text{for CSA A23.3-94} \\ 0.65 & \text{for CSA A23.3-04 (cast-in-place)} \\ 0.70 & \text{for CSA A23.3-04 (precast)} \end{cases}$$

The material resistance factor for steel, ϕ_s , is equal to 0.90.

¹⁹ ACI 318-05, 9.3.2, 10.3.3, 10.3.4; ACI 318-02, 9.3.2, 10.3.3, 10.3.4

²⁰ CSA A23.3-04, 8.4.2, 16.1.3; CSA A23.3-94, 8.4.2

²¹ CSA A23.3-04, 8.4.3; CSA A23.3-94, 8.4.3

Additionally, the design axial capacity (for all ACI and CSA standards) is capped²² at 0.85 of the maximum axial capacity for sections with spiral reinforcement or at 0.80 for sections with tie reinforcement.

8. In the investigation mode the program will calculate capacity for any provided area of reinforcement. However, if the reinforcement area falls below the code-specified²³ minimum of 0.01 times the gross area, A_g , then two options, *Architectural* or *Structural*, are available.

By default *Architectural* option is selected for which the capacity of the section is reduced. For the ACI codes, the reduction results from multiplying the maximum concrete stress, f'_c , by the ratio of reinforcement area to $0.01A_g$. This produces the same effect as reducing the effective concrete area²⁴ to achieve ratio of reinforcement area to gross concrete area equal to 0.01. For the CSA standards²⁵, the factored axial and flexural resistances are multiplied by ratio $0.5(1 + \rho_t / 0.01)$ for the 04 edition and $\rho_t / 0.01$ for the 94 edition.

For *Structural* option, the section is treated “as is” without any reductions in capacity. This option is provided for informational purposes only, since per all codes supported by spColumn, capacity of compression members with reinforcement area less than $0.01A_g$ has to be reduced and areas below $0.005A_g$ are not allowed.

9. Under the Design option, the reinforcement ratio cannot be less than 1.0% if *Structural* column type is selected in design criteria and 0.5% in case of *Architectural* column type. For *Architectural* type, the capacity of the designed column is reduced as described above. Additionally, *User Defined* type is provided in the design criteria, which allows designs with reinforcement ratios not less than 0.1%. No reduction in capacity is applied for *User Defined* column type.
10. Maximum reinforcement ratio²⁶ for *Structural* and *Architectural* options in both Investigation and Design modes is 8%. For *User Defined* type in the Design mode the maximum reinforcement ratio is set to 20%.

²² ACI 318-05, 10.3.6; ACI 318-02, 10.3.6; CSA A23.3-04, 10.10.4; CSA A23.3-94, 10.10.4

²³ ACI 318-05, 10.9.1; ACI 318-02, 10.9.1; CSA A23.3-04, 10.9.1; CSA A23.3-94, 10.9.1

²⁴ ACI 318-05, 10.8.4; ACI 318-02, 10.8.4

²⁵ CSA A23.3-04, 10.10.5; CSA A23.3-94, 10.10.5

²⁶ ACI 318-05, 10.9.1; ACI 318-02, 10.9.1; CSA A23.3-04, 10.9.2; CSA A23.3-94, 10.9.2

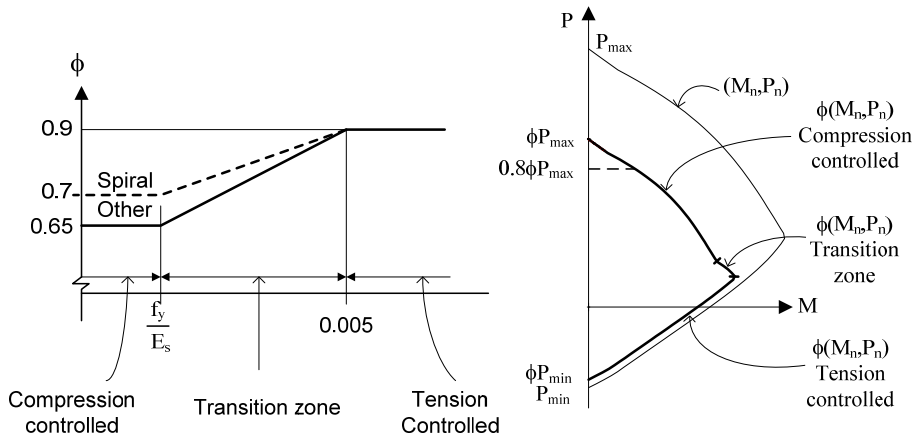

Figure 2-2 Reduction factors for Flexure and Axial Loads per ACI code

B – Sign Convention

1. Positive axial forces are compressive and negative axial forces are tensile.

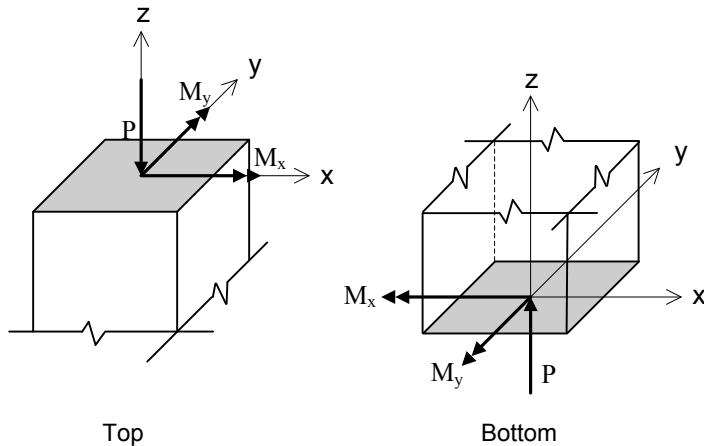

Figure 2-3 Positive axial force and bending moments (internal forces)

2. Looking in plan at the section with z-axis pointing outwards, the positive x-axis points to the right and the positive y-axis points up. For this section,

vectors of positive bending moments have the same orientation as their corresponding axes x and y . Thus, a positive bending moment about the x -axis, M_x , produces tension at the top face of the section and compression at the bottom face. A positive bending moment about the y -axis, M_y , produces tension at the left face of the section and compression at the right face.

3. If service loads are input, moment loads at the upper (top) and lower (bottom) ends of the column are needed. Top and bottom moment loads of opposite signs produce single curvature bending. Top and bottom moment loads of the same sign produce double curvature bending.

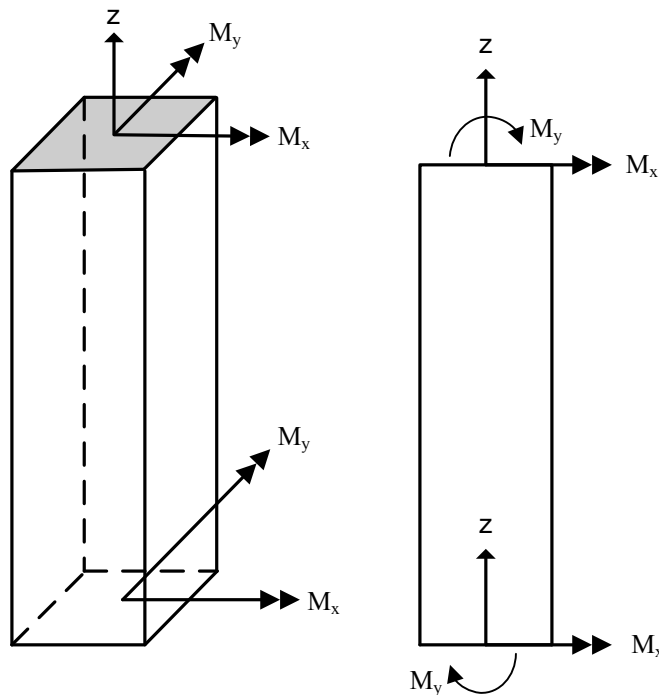

Figure 2-4 Positive moment loads (external forces)

Positive moment loads at the upper end of the column coincide with positive bending moments. However, at the lower end, positive moment loads produce effects opposite to positive bending moments. Therefore spColumn changes

the sign of the service moment at the lower end to convert it from a moment load to a bending moment.

Axial load is assumed to be constant so it is input only as for the upper end where positive axial load coincides with positive axial force.

4. If factored loads are input, they are considered to be applied at a section pointing upwards so that they have the same orientations as positive axial force and positive bending moments.

C – Section Investigation

1. The computations performed when investigating a section depend on the selected load mode:

- a) Factored loads – for the axial load of each load point, the moment capacity and the ratio of design-to-applied moment are computed. For a biaxial run, the computed M_x and M_y moment capacities are at the same angle as that produced by the applied M_x and M_y moments. In uniaxial case the program also reports the depth of neutral axis and maximum steel strain corresponding to the calculated moment capacity. For the ACI code, the value of strength reduction factor is also reported.

spColumn allows defining up to 50 load combinations. The user has full control over the combinations. The program contains predefined (built into the program) default primary load combinations for the supported codes. These default combinations are created when starting a new project. The default load combinations of the Dead (D), Live (L), Wind (W), Earthquake (E) and Snow (S) loads considered by the program are shown below. For the ACI 318-02 and 05 codes²⁷:

U1	=	1.4D
U2	=	1.2D + 1.6L + 0.5S
U3	=	1.2D + 1.0L + 1.6S
U4	=	1.2D + 0.8W + 1.6S
U5	=	1.2D + 1.0L + 1.6W + 0.5S
U6	=	0.9D + 1.6W
U7	=	1.2D – 0.8W + 1.6S
U8	=	1.2D + 1.0L – 1.6W + 0.5S
U9	=	0.9D – 1.6W

²⁷ ACI 318-05, 9.2; ACI 318-02, 9.2;

$$\begin{aligned}
 U10 &= 1.2D + 1.0L + 1.0E - 0.2S \\
 U11 &= 0.9D + 1.0E \\
 U12 &= 1.2D + 1.0L - 1.0E + 0.2S \\
 U13 &= 0.9D - 1.0E
 \end{aligned}$$

For the CSA A23.3-94 code²⁸:

$$\begin{aligned}
 U1 &= 1.25D \\
 U2 &= 1.25D + 1.5L \\
 U3 &= 1.25D + 1.05L + 1.05W \\
 U4 &= 1.25D + 1.5W \\
 U5 &= 0.85D + 1.5W \\
 U6 &= 1.0D + 1.0L + 1.0E \\
 U7 &= 1.0D + 1.0E \\
 U8 &= 1.25D + 1.05L - 1.05W \\
 U9 &= 1.25D - 1.5W \\
 U10 &= 0.85D - 1.5W \\
 U11 &= 1.0D + 1.0L - 1.0E \\
 U12 &= 1.0D - 1.0E
 \end{aligned}$$

For the CSA A23.3-04 code²⁹:

$$\begin{aligned}
 U1 &= 1.4D \\
 U2 &= 1.25D + 1.5L \\
 U3 &= 1.25D + 1.5L + 0.5S \\
 U4 &= 1.25D + 1.5L + 0.4W \\
 U5 &= 1.25D + 1.5L - 0.4W \\
 U6 &= 0.9D + 1.5L \\
 U7 &= 0.9D + 1.5L + 0.5S \\
 U8 &= 0.9D + 1.5L + 0.4W \\
 U9 &= 0.9D + 1.5L - 0.4W \\
 U10 &= 1.25D + 1.5S \\
 U11 &= 1.25D + 0.5L + 1.5S \\
 U12 &= 1.25D + 0.4W + 1.5S \\
 U13 &= 1.25D - 0.4W + 1.5S \\
 U14 &= 0.9D + 1.5S
 \end{aligned}$$

²⁸ CSA A23.3-94, 8.3.2 (conservatively assuming storage and assembly occupancies)

²⁹ CSA A23.3-04, 8.3.2; CSA A23.3-04, Annex C, Table C1; NBCC 2005 [5], Table 4.1.3.2

U15	=	$0.9D + 0.5L + 1.5S$
U16	=	$0.9D + 0.4W + 1.5S$
U17	=	$0.9D - 0.4W + 1.5S$
U18	=	$1.25D + 1.4W$
U19	=	$1.25D + 0.5L + 1.4W$
U20	=	$1.25D + 1.4W + 0.5S$
U21	=	$1.25D - 1.4W$
U22	=	$1.25D + 0.5L - 1.4W + 0.5S$
U23	=	$1.25D - 1.4W + 0.5S$
U24	=	$0.9D + 0.5L + 1.4W$
U25	=	$0.9D + 0.5L + 1.4W$
U26	=	$0.9D + 1.4W + 0.5S$
U27	=	$0.9D - 1.4W$
U28	=	$0.9D + 0.5L - 1.4W$
U29	=	$0.9D - 1.4W + 0.5S$
U30	=	$1.0D + 1.0E$
U31	=	$1.0D + 0.5L + 1.0E + 0.25S$
U32	=	$1.0D - 1.0E$
U33	=	$1.0D + 0.5L - 1.0E + 0.25S$

- b) Service loads – the program calculates the factored loads using the input load combinations. If slenderness effects are to be checked and the column is found to be slender, the applied moments are magnified according to Procedures E and F. For each calculated factored load, the same computations described in (a) above are performed.
- c) Control points – for several key points on the interaction diagram, the program calculates axial load and moment capacity together with the neutral axis depth and maximum steel strain corresponding to the respective moment capacity. For ACI code, strength reduction factor is also reported. The following key points are used by the program: maximum compression, allowable compression, point where steel stress is zero, point where steel stress is $0.5 f_y$, balanced point, pure flexure and maximum tension. For ACI code, an additional control point is introduced where maximum steel strain is equal to 0.005 (tension control limit).

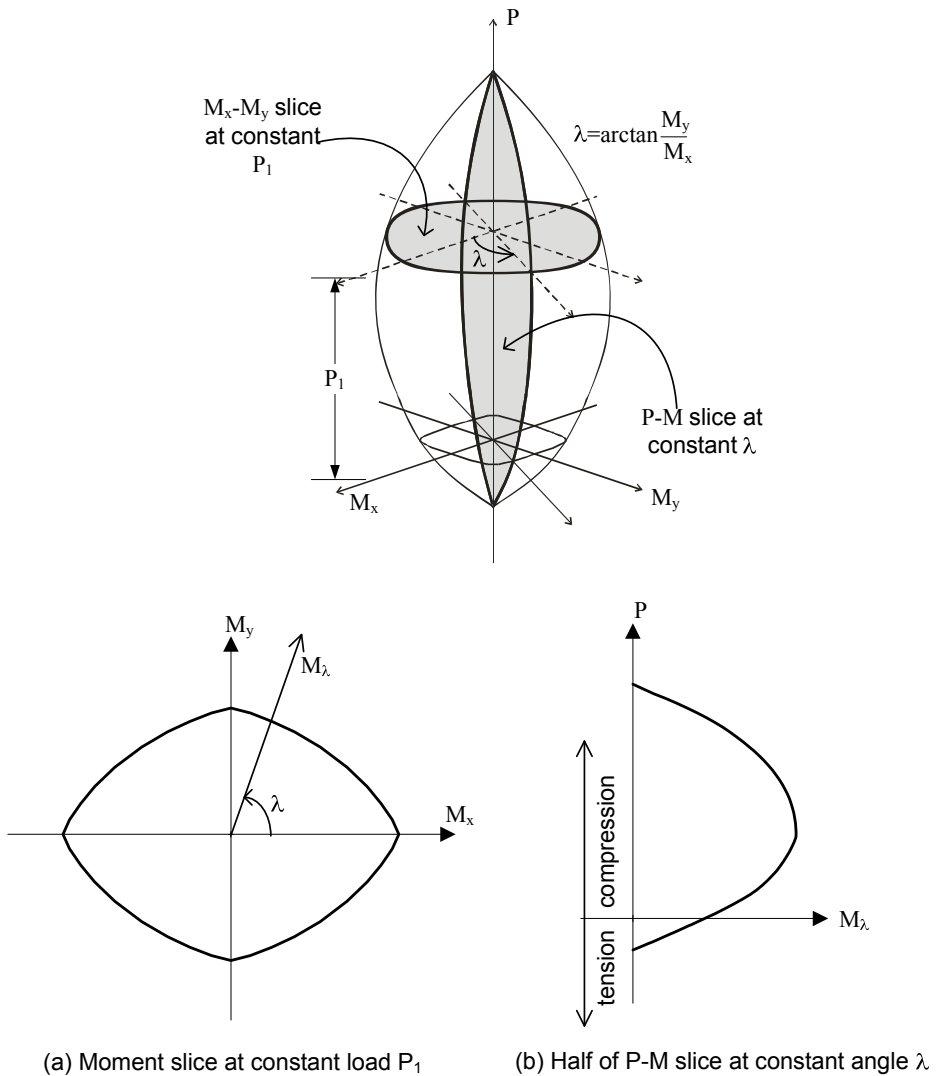

Figure 2-5 Interaction Surface for Combined Axial Load and Biaxial Bending

- d) Axial loads – for each input axial load, the program calculates the positive and negative moment capacities together with the corresponding neutral axis depths and maximum steel strains. For ACI code, strength reduction factors are also reported.
2. The program also computes the interaction diagram (uniaxial runs) or the three-dimensional failure surface (biaxial runs) of the input section. The values of maximum compressive axial load capacity and maximum tensile load capacity are computed. These two values set the range within which the moment capacities are computed for a predetermined number of axial load values.
- a) For uniaxial runs, positive and negative moment capacities about only the selected axis are computed. Moment capacities about the orthogonal axis are ignored. To compute the moment capacity at a certain level of axial load, the neutral axis angle is held constant, parallel to the selected axis. The neutral axis depth is adjusted to arrive at the desired axial load capacity. This is done for all the predetermined values of axial load.
 - b) For biaxial runs, the same predetermined values of axial load are utilized. For each level of axial load, the section is rotated in 10-degree increments from 0 degrees to 360 degrees and the M_x and M_y moment capacities are computed. Thus for each level of axial load, an M_x - M_y contour is developed. Repeating this for the entire range of axial loads, the three-dimensional failure surface is computed.

Also for each point on the interaction diagram or on the three-dimensional failure surface, the program calculates the location of the neutral axis (expressed in terms of depth and angle of the neutral axis), maximum steel strain, and (for ACI codes only) the strength reduction factor.

D – Section Design

1. Based on the specified minimum, maximum and increment specified for the section and the reinforcing bars, the program selects the smallest section with the least amount of reinforcement for which the load-moment capacity exceeds the applied loads. If service loads are input, they are factored using the input load combinations. Depending on the design criteria the user selects, the least amount of reinforcement the program searches for means either the smallest number of bars or the smallest steel area.
2. The program starts the design by trying the smallest section (minimum dimensions) and the least amount of reinforcing bars. The program verifies

that the ratio of provided reinforcement is always within the specified minimum and maximum ratios. Furthermore, the bar spacing is always kept greater than or equal to the larger of 1.5 times the bar diameter or 1.5 in. [40 mm] (unless otherwise specified by the user)³⁰.

3. A section fails the design if, for the design axial load, the ratio of design-to-applied moment is less than 1.0 (unless otherwise specified in the Design Criteria box).
4. Once a section passes the design, its capacity is computed and the computations explained in Procedure C above are performed.

E – Moment Magnification for Nonsway Columns

1. If properties of framing members are input, spColumn computes the non-sway condition effective length factor, k_b , as the smaller of³¹:

$$0.7 + 0.05(\psi_A + \psi_B) \leq 1.0$$

$$0.85 + 0.05\psi_{\min} \leq 1.0$$

Where ψ is the ratio of $\Sigma(EI/L)$ of columns to $\Sigma(EI/L)$ of beams in a plane at one end of the column, ψ_A and ψ_B are the values of ψ at the upper end and the lower end of the column, respectively, and ψ_{\min} is the smaller of ψ_A and ψ_B .

The value of k_b must always be between 0.5 and 1.0. The moment of inertia used in computing ψ is the gross moment of inertia multiplied by the cracked section coefficients³² (specified in the Slenderness Factors box).

2. The smaller and larger factored column end moments M_1 and M_2 , respectively, are computed. M_1 is positive if the column is bent in single curvature and is negative if the column is bent in double curvature. M_2 is always positive.
3. For the ACI code, slenderness effects will be considered if³³

³⁰ ACI 318-05 7.6.3; ACI 318-02 7.6.3

³¹ ACI 318-05 R10.12.1; ACI 318-02 R10.12.1

³² ACI 318-05 10.11.1, 10.12.1; ACI 318-02 10.11.1, 10.12.1; CSA A23.3-04 10.14.1.2, 10.15.1; CSA A23.3-94 10.14.1, 10.15.1

$$\frac{kl_u}{r} \geq 34 - 12 \frac{M_1}{M_2} \leq 40.$$

For the CSA standard³⁴

$$\frac{kl_u}{r} \geq \frac{25 - 10 \frac{M_1}{M_2}}{\sqrt{\frac{P_f}{f'_c A_g}}},$$

where l_u is the unsupported column length and $r = \sqrt{\frac{I_g}{A}}$ is the radius of gyration. The ratio M_1/M_2 is always greater than or equal to -0.5. If both moments are equal to zero, the program conservatively assumes the ratio of $M_1/M_2 = 1.0$.

4. If the ratio kl_u/r exceeds 100, slenderness effects using this approximate procedure cannot be applied³⁵. A more exact method must be used. In this case, the program issues a warning message and aborts design or investigation procedure³⁶.
5. The factor C_m is computed as³⁷:

$$C_m = 0.6 + 0.4 \frac{M_1}{M_2} \geq 0.4.$$

If $M_1 = M_2 = 0$, the program assumes C_m to be equal to³⁸ 1.0. This is consistent with the assumption made above (in point 3).

6. Assuming that only dead loads are sustained, the factor β_d is computed as the ratio of maximum factored axial dead load to the total factored axial load for the load combination under consideration³⁹.
7. Flexural stiffness EI is computed as⁴⁰:

³³ ACI 318-05 10.12.2; ACI 318-02 10.12.2

³⁴ CSA A23.3-04 10.15.2; CSA A23.3-94 10.15.2

³⁵ ACI 318-05 10.11.5; ACI 318-02 10.11.5; CSA A23.3-04 10.13.2; CSA A23.3-94 10.13.2

³⁶ Interaction diagram will still be constructed but no design or investigation will be performed.

³⁷ ACI 318-05 10.12.3.1; ACI 318-02 10.12.3.1; CSA A23.3-04 10.15.3.2; CSA A23.3-94 10.15.3.1

³⁸ ACI 318-05 10.12.3.2; ACI 318-02 10.12.3.2

³⁹ ACI 318-05 10.11.1; ACI 318-02 10.0; CSA A23.3-04 2.3; CSA A23.3-94 10.0

$$EI = \frac{0.2E_c I_g + E_s I_{se}}{1 + \beta_d}$$

where E_c is the modulus of elasticity of concrete, E_s is the modulus elasticity of steel, I_g is the gross moment of inertia of the concrete section, and I_{se} is the moment of inertia of reinforcement.

8. The critical buckling load, P_c , is computed as⁴¹:

$$P_c = \frac{\pi^2 EI}{(k l_u)^2}.$$

9. The nonsway moment magnification factor, δ_b , is computed as⁴²:

$$\delta_{ns} = \frac{C_m}{1 - \frac{P_u}{\phi_m P_c}} \geq 1.0,$$

where the member resistance factor, ϕ_m , is equal to 0.75 (may be modified using the Slenderness Factors input box) and P_u is the factored axial load for the load combination under consideration.

10. The moment due to minimum eccentricity, e_{min} , is computed as⁴³:

$$M_{min} = P_u e_{min}, \text{ where}$$

$$e_{min} = 0.6 + 0.03 h, \text{ with } h \text{ in in,}$$

$$e_{min} = 15 + 0.03 h, \text{ with } h \text{ in mm,}$$

and h is the section dimension (diameter for circular sections) in the direction being considered.

11. The magnified moment, M_c , is the larger⁴⁴ of $\delta_{ns} M_2$ and $\delta_{ns} M_{min}$.

⁴⁰ ACI 318-05 10.12.3 Eq. 10-11; ACI 318-02 10.12.3. Eq. 10-10; CSA A23.3-04 10.15.3 Eq. 10-18; CSA A23.3-94 10.15.3.1 Eq. 10-18

⁴¹ ACI 318-05 10.12.3 Eq. 10-10; ACI 318-02 10.12.3 Eq. 10-10; CSA A23.3-04 10.15.3.1 Eq. 10-17; CSA A23.3-94 10.15.3 Eq. 10-17

⁴² ACI 318-05 10.12.3 Eq. 10.9; ACI 318-02 10.12.3 Eq. 10.9; CSA A23.3-04 10.15.3.1 Eq. 10-16; CSA A23.3-94 10.15.3 Eq 10-16

⁴³ ACI 318-05 10.12.3.2; ACI M318-05 10.12.3.2; ACI 318-02 10.12.3.2; ACI M318-02 10.12.3.2; CSA A23.3-04 10.15.3.1; CSA A23.3-94 10.15.3.

F – Moment Magnification for Sway Columns

1. If properties of framing members are input, spColumn computes the sway condition effective length factor, k , using the following simplified equations⁴⁵:

if both ends are restrained and $\psi_m < 2$, $k = 0.05(20 - \psi_m)\sqrt{1 + \psi_m} \geq 1.0$,

if both ends are restrained and $\psi_m \geq 2$, $k = 0.9\sqrt{1 + \psi_m} \geq 1.0$,

if the upper end is hinged, $k = 2 + 0.3\psi_B$,

if the lower end is hinged, $k = 2 + 0.3\psi_A$,

if both ends are hinged, $k = 30$.

Where ψ is the ratio of $\Sigma(EI/L)$ of columns to $\Sigma(EI/L)$ of beams in a plane at one end of the column, ψ_A and ψ_B are the values of ψ at the upper end and the lower end of the column, respectively, and ψ_m is the average of ψ_A and ψ_B .

An end is determined to be hinged if its ψ is very large. This happens in the case where $\Sigma(EI/L)$ of beams is too small (or zero) relative to the $\Sigma(EI/L)$ of columns at that end. In this case, the program outputs 999.9 for the value of ψ . The moment of inertia used in computing ψ is the gross moment of inertia multiplied by the cracked section coefficients⁴⁶ (specified in the Slenderness Factors input box).

2. The smaller and larger factored non-sway column end moments M_{1ns} and M_{2ns} , respectively, are computed. These are factored moments due to dead, live, and snow loads assumed to cause no appreciable sidesway⁴⁷. M_{1ns} is positive if the column is bent in single curvature and is negative if the column is bent in double curvature. M_{2ns} is always positive.

⁴⁴ ACI 318-05 10.12.3.2; ACI 318-02 10.12.3.2; CSA A23.3-04 10.15.3.1; CSA A23.3-94 10.15.3

⁴⁵ ACI 318-05 R10.12.1; ACI 318-02 R10.12.1

⁴⁶ ACI 318-05 10.11.1, 10.13.1; ACI 318-02 10.11.1, 10.13.1; CSA A23.3-04 10.14.1.2, 10.16.1; CSA A23.3-94 10.14.1, 10.16.1

⁴⁷ ACI 318-05 2.1; ACI 318-02 10.0; CSA A23.3-04 2.3; CSA A23.3-94 10.0

3. The smaller and larger factored sway column end moments M_{1s} and M_{2s} , respectively, are computed. These are factored moments due to lateral loads (wind and earthquake). M_{1s} is positive if the column is bent in single curvature and is negative if the column is bent in double curvature. M_{2s} is always positive.
4. For the ACI code⁴⁸, slenderness effects will be considered if $kl_u/r \geq 22.0$. For the CSA standard, all sway columns are designed for slenderness effects.
5. If the ratio kl_u/r exceeds 100, slenderness effects using this approximate procedure cannot be applied⁴⁹. A more exact method must be used. In this case, the program issues a warning message and aborts design or investigation procedure⁵⁰.
6. Flexural stiffness EI is calculated as⁵¹:

$$EI = \frac{0.2E_c I_g + E_s I_{se}}{1 + \beta_d}$$

where E_c is the modulus of elasticity of concrete, E_s is the modulus elasticity of steel, I_g is the gross moment of inertia of the concrete section, I_{se} is the moment of inertia of reinforcement and β_d is taken as zero with the assumption that shear due to lateral loads is not sustained in most frames⁵².

7. The critical buckling load, P_c , is computed as⁵³:

$$P_c = \frac{\pi^2 EI}{(kl_u)^2}$$

8. The sway moment magnification factor, δ_s , is computed as⁵⁴:

⁴⁸ ACI 318-05 10.13.2; ACI 318-02 10.13.2

⁴⁹ ACI 318-05 10.11.5; ACI 318-02 10.11.5; CSA A23.3-04 10.13.2; CSA A23.3-94 10.13.2

⁵⁰ Interaction diagram will still be constructed but no design or investigation will be performed.

⁵¹ ACI 318-05 10.12.3 Eq. 10-11; ACI 318-02 10.12.3 Eq. 10-10; CSA A23.3-04 10.16.3.2, 10.15.3 Eq. 10-18; CSA A23.3-94 10.16.3.2, 10.15.3.1 Eq. 10-18

⁵² Ref. [7] pp 581 (first paragraph from the bottom)

⁵³ ACI 318-05 10.12.3 Eq. 10-10; ACI 318-02 10.12.3 Eq. 10-10; CSA A23.3-04 10.16.3.2, 10.15.3.1 Eq. 10-17; CSA A23.3-94 10.16.3.2, 10.15.3 Eq. 10-17

⁵⁴ ACI 318-05 10.13.4.3; ACI 318-02 10.13.4.3; CSA A23.3-04 10.16.3.2; CSA A23.3-94 10.16.3.2

$$\delta_s = \frac{1.0}{1 - \frac{\Sigma P_u}{\phi_m \Sigma P_c}} \geq 1.0,$$

where the member resistance factor, ϕ_m , is equal to 0.75.

ΣP_u is taken as the factored axial load for the load combination under consideration times the ratio $\Sigma P_u / P_u$, i.e. ⁵⁵ $\Sigma P_u = P_u (\Sigma P_u / P_u)$.

ΣP_c is taken as the critical buckling load for the load combination under consideration times the ratio $\Sigma P_c / P_c$, i.e. $\Sigma P_c = P_c (\Sigma P_c / P_c)$.

ϕ_k and the ratios $\Sigma P_u / P_u$ and $\Sigma P_c / P_c$ may be modified using the Slenderness Factors input box.

9. If $\frac{l_u}{r} > \frac{35}{\sqrt{\frac{P_u}{f'_c A_g}}}$, the magnified moment is computed as⁵⁶:

$$M_1 = M_{1ns} + \delta_s M_{1s},$$

$$M_2 = M_{2ns} + \delta_s M_{2s}.$$

10. If $\frac{l_u}{r} > \frac{35}{\sqrt{\frac{P_u}{f'_c A_g}}}$, the nonsway moment magnification factor, δ_b , is computed

according to steps 1 through 9 as described in Procedure E above. In step 7, however, β_d is computed for the load combination under consideration. The magnified moment is computed as⁵⁷:

$$M_1 = \delta_b (M_{1ns} + \delta_s M_{1s}),$$

$$M_2 = \delta_b (M_{2ns} + \delta_s M_{2s}).$$

⁵⁵ To minimize required input, the program uses one value of ratio $\Sigma P_u / P_u$ for all load combinations. However, the ratio can vary depending on the combination under consideration. In this case, it will be conservative to use the highest value of the ratio.

⁵⁶ ACI 318-05 10.13.3; ACI 318-02 10.13.3; CSA A23.3-04 10.16.2; CSA A23.3-94 10.16.2

⁵⁷ ACI 318-05 10.13.5; ACI 318-02 10.13.5; CSA A23.3-04 10.16.4; CSA A23.3-94 10.16.4

References

- [1] Building Code Requirements for Structural Concrete (ACI 318-05) and Commentary (ACI 318R-05), American Concrete Institute, 2005
- [2] Building Code Requirements for Structural Concrete (ACI 318-02) and Commentary (ACI 318R-02), American Concrete Institute, 2002
- [3] A23.3-04, Design of Concrete Structures, Canadian Standards Association, 2004
- [4] A23.3-94, Design of Concrete Structures, Canadian Standards Association, 1994 (Reaffirmed 2000)
- [5] National Building Code of Canada 2005, Volume 1, Canadian Commission on Buildings and Fire Codes, National Research Council of Canada, 2005
- [6] Notes on ACI 318-05 Building Code Requirements for Structural Concrete with Design Applications, Edited by Mahmoud E. Kamara and Basile G. Rabbat, Portland Cement Association, 2005
- [7] MacGregor J.G., Wight J.K., Reinforced Concrete, Mechanics and Design, Fourth Edition, Pearson Prentice Hall, 2005

Chapter 3

spColumn Interface

Main Window

Most windows have certain elements in common, such as a title bar and menus. Not all windows, however, have every element. To learn more about how to use window elements, refer to your Microsoft Windows manual. The following is a list of the spColumn window components.

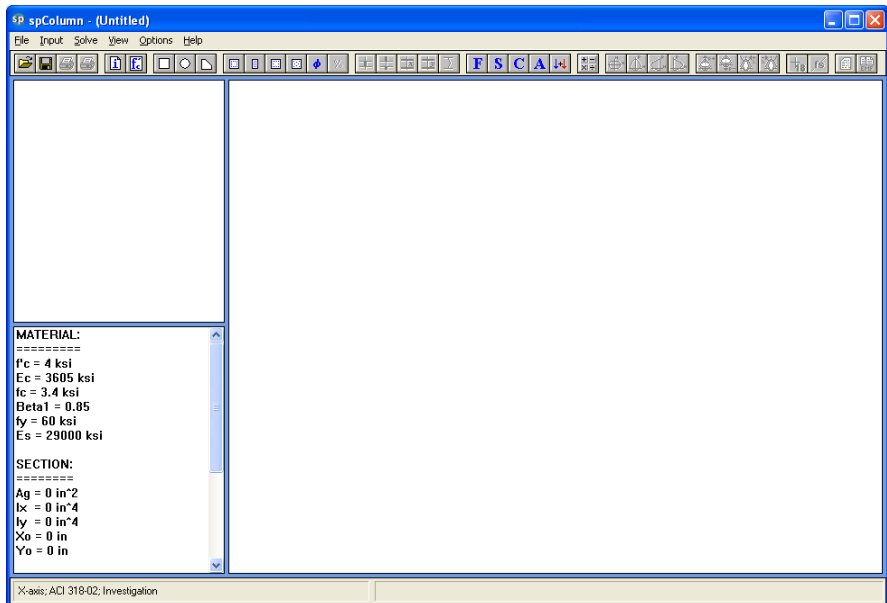

Control-Menu Box:

The Control-menu box is located in the upper-left corner of the window and includes commands for sizing, moving, enlarging, restoring, and closing the window, as well as switching to other applications. To access the Control-menu

box using the mouse, click the left mouse button on the box; using the keyboard, press ALT+‘ (space).

Title Bar:

The Title bar displays the name of the application (spColumn in this case), along with the name of the current data file in use. If the data have not been saved into a file, the word Untitled is displayed in the Title bar.

Menu Bar:

The Menu bar is located directly below the Title bar. It lists the available menus. A menu contains a list of commands or actions you can execute.

Tool Bar:

The Tool bar is located directly below the Menu bar. It contains a collection of buttons (or icons) that provide a shortcut to accessing the menu commands. The Tool bar buttons can only be accessed using the mouse.

Information Bar:

The Information bar is located on the left side of the spColumn window. The top part displays the column cross section. The bottom part is a list of selected input data echo.

Graphics Area:

The Graphics area covers most of the window. This is where the interaction diagram is shown.

Status Bar:

The Status bar is located along the bottom of the window. It displays important information such as units, design code, cursor position, and helpful messages.

File Menu

The **File** menu is used for working with data files, printing results, and exiting the program.

New (CTRL+N)

Clears any input data and returns the data to the default values so that a new data file may be input.

Open (CTRL+O)

Opens an existing spColumn data file.

Save (CTRL+S)

Saves the changes you have made to the current data file under that same filename.

New	Ctrl+N
Open...	Ctrl+O
Save	Ctrl+S
Save As...	
Import...	Ctrl+I
Export	
Revert...	
Print Results...	
Print Screen...	Ctrl+P
1 C:\Program Files\Struc...\Example01.col	
2 C:\Program Files\Struc...\Example02.col	
3 C:\Program Files\Struc...\Example03.col	
4 C:\Program Files\Struc...\Example04.col	
Exit	

Save As

Names or renames a data file.

Import (CTRL+I)

Reads geometry, reinforcement or loads data from an ASCII (TXT) file.

Export

Exports interaction diagram and 3D failure surface to Comma-Separated Values (CSV) files (readable by most spreadsheet programs) or Tab-Delimited Text (TXT) files, or exports a column section to Drawing Exchange Format (DXF) file (readable by most CAD programs).

Revert

Discards any changes to the data and returns to the last version of saved data. This option will only be available if the file has been modified since the last file save.

Print Results

Displays Print dialog box and prints the results in the text form to the selected printer.

Print Screen (CTRL+P)

Displays Print dialog box and prints the results similarly as they appear on the screen.

Recent Data File List

Provides quick access to up to four recently open data files.

Exit

Quits the spColumn program. If you have made any changes to your data and have not saved them, spColumn will prompt you whether you want to save or abandon any changes you have made before you exit.

Input Menu

The Input menu includes commands used to input the data needed to define a problem.

General Information

Input labels to identify the input and select from several options that control the run.

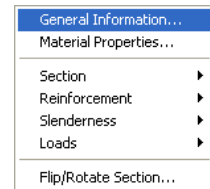

Material Properties

Input the material properties for concrete and reinforcement.

Section

Rectangular: Input the dimensions of a rectangular section.

Circular: Input the dimension of a circular section.

Irregular: Execute spSection to define an irregularly shaped section. See Chapter 6.

Reinforcement

All Sides Equal: Input a reinforcement pattern in which all the bars are of one size, and the number of bars is the same on all four sides of a rectangular layout or are equally spaced for a circular layout. *Available for rectangular and circular sections.*

Equal Spacing: Input a reinforcement pattern in which all bars are of one size and are uniformly spaced on all four sides of a rectangular layout. *Available for rectangular sections only.*

Sides Different: Input a reinforcement pattern in which each one of the four sides of a rectangular section has a certain number of bars and a certain bar size. *Available for rectangular sections only.*

Irregular Pattern: Input a reinforcement pattern in such a way that bars of any size can be placed anywhere within the column section.

Confinement: Input confinement-related data such as the capacity reduction factors and the size of ties associated with the longitudinal bar size.

Design Criteria: Input parameters that govern the design of the section such as column type, minimum and maximum reinforcement ratio, bar selection criterion, minimum clear spacing, and design/required ratio.

Slenderness

Design Column: Input data needed for slenderness related to the column being considered.

Column Above/Below: Input data needed for slenderness related to the columns above and below the design column.

X-Beams: Input data needed for slenderness related to beams perpendicular to the x-axis framing into the design column.

Y-Beams: Input data needed for slenderness related to beams perpendicular to the y-axis framing into the design column.

Factors: Input factors that affect slenderness calculations.

Loads

Factored: Input factored axial loads and moments. *This command is available for non-slender columns only.*

Service: Input service-level (dead, live, wind, earthquake, and snow) axial loads and moments about the active axis. Moments are input at the top and at the bottom of the column. *This command must be used for slender columns.*

Control Points: If chosen, the program will compute key points on the interaction diagram. In addition, the splice regions are shown on the interaction diagram. *This*

option is available for short (non-slender) columns under the investigation option only and for uniaxial runs only.

Axial Loads: Input a group of axial loads with an initial value, a final value, and an increment. *This command is available for uniaxial short (non-slender) columns only.*

Load Combinations: Input the load factors and combinations used to combine the service loads.

Flip/Rotate Section

Flip an unsymmetrical section about an axis or rotate an irregular section (created in spSection).

Solve Menu

The **Solve** menu contains commands used to perform the design or investigation, trace through the design process, and send the output to a text file.

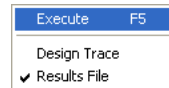

Execute (F5)

Executes the solver.

Design Trace

Toggles trace-through-a-design On and Off.

Results File

Toggles output-to-results-file On and Off.

View Menu

The View menu commands used to customize the display screen to suit your viewing needs, view the interaction diagram at a given angle, view the contour for a given axial load, superimpose an interaction diagram or a contour from another run, and view the results file.

Redraw

Redraws the displayed diagram or contour and clear any superimposed curves.

Copy Diagram to Clipboard (CTRL+C)

Copies the displayed diagram or contour to clipboard so that in can be pasted in other applications .

Information Bar

Shows or hides the Information bar.

Tool Bar

Shows or hides the Tool bar.

Status bar

Shows or hides the Status bar.

Grid

Shows or hides the grid.

Mx-My Diagram

View a contour of the failure surface sliced at a constant axial load.

P-M Diagram - Full

View an interaction diagram sliced at a constant (M_x , M_y) angle drawn for both positive and negative moments.

P-M Diagram - M positive

View an interaction diagram sliced at a constant (M_x , M_y) angle drawn for the positive moments only.

P-M Diagram - M negative

View an interaction diagram sliced at a constant (M_x , M_y) angle drawn for the negative moments only.

Next Load (Ctrl + Arrow Up)

View an M_x - M_y interaction diagram for the factored load next to the one displayed currently on the interaction diagram.

Redraw	
Copy Diagram to Clipboard Ctrl+C	
<input checked="" type="checkbox"/>	Information Bar
<input checked="" type="checkbox"/>	Tool Bar
<input checked="" type="checkbox"/>	Status Bar
<input type="checkbox"/>	Grid
<input checked="" type="checkbox"/>	Mx-My Diagram
<input type="checkbox"/>	P-M Diagram - Full
<input type="checkbox"/>	P-M Diagram - M positive
<input type="checkbox"/>	P-M Diagram - M negative
	Next Load Ctrl+Arrow Up
	Previous Load Ctrl+Arrow Down
	Next Angle Ctrl+Arrow Right
	Previous Angle Ctrl+Arrow Left
<input checked="" type="checkbox"/>	Show Load Point Labels
<input type="checkbox"/>	Show Splice Lines
Superimpose...	
Results...	F6

Previous Load (Ctrl + Arrow Up)

View an M_x - M_y interaction diagram for the factored load previous to the one displayed currently on the interaction diagram.

Next Angle

View a P-M interaction diagram at the (M_x , M_y) angle corresponding to factored load next to the one currently in the graphics area.

Previous Angle

View a P-M interaction diagram at the (M_x , M_y) angle corresponding to factored load previous to the one currently in the graphics area.

Show Load Point Labels

Show/Hide Load Point labels of factored loads input.

Show Splice Lines

Show the P-M splice lines corresponding to $f_s=0$ and $f_s=0.5f_y$.

Superimpose

Superimpose a diagram from a previously saved run over the current diagram.

Results (F6)

View the results file after a successful run has been performed with the **Solve | Results File** option ON.

Options

The **Options** menu contains commands used to view or change spColumn's default settings and reinforcement bar set.

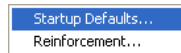

Startup Defaults

View or Edit application startup default settings.

Reinforcement

View or Edit reinforcing bar set.

Help Menu

spColumn Help

Lists all the available help topics about the program.

spColumn Manual

Opens spColumn Manual in the default PDF viewer.

Check for Updates

Checks if a newer version of the program is available. Internet connection is required.

About spColumn

Shows the version number of the program, the licensing information, and the copyright information. In the case of a trial license, the expiration date is given as well as the locking code which is needed to obtain a standalone license.

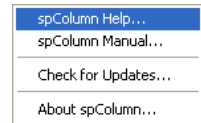

Chapter 4

Operating the Program

This chapter is divided into sections that follow the order in which commands and options appear in the program.

Creating a New Data File

When spColumn is first loaded, the program is ready to obtain input for a new file. The data will not have a filename associated with it; therefore, Untitled appears in the Title bar.

- Select **File | New**. This clears the screen and returns to the default settings of the program. If existing data have been changed prior to selecting the **New** command, spColumn asks if you want to save the data. At any time after starting a new file, use the **File | Save As** command to give the file a name.

Opening an Existing Data File

You can open spColumn data files that were previously saved to disk. spColumn reads files that have been saved in binary format (with COL extension) or text input format (with CTI extension).

- Select **File | Open**. A dialog box appears.
- All files with the COL extension contained in the current drive and directory are displayed in the FILE NAME list box.
- To open a file that exists in another drive or directory, select the drive or directory you want from the Drives drop-down list or the Directories list box respectively.
- To open a file in spColumn Text Input (CTI) format⁵⁸, use FILE TYPE list box to select this type.

⁵⁸ See Appendix for description of the CTI format

- From the FILE NAME list box, select the file to be opened, or simply type its name in the text box.
- Choose the OK button.

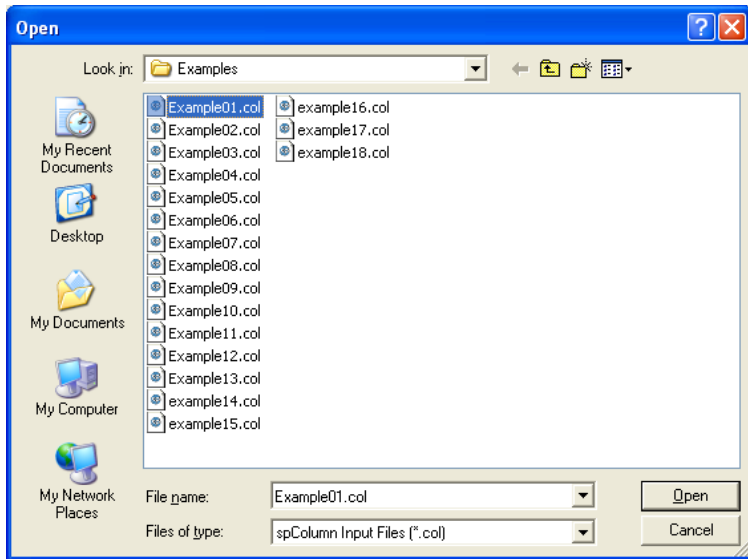

Saving the Data

To save the data with the same filename:

At anytime while editing a data file that has previously been saved under a filename, choose **File | Save** to save the changes under the same file name. Selecting the **File | Save** command before giving the data file a name displays the Save As dialog box.

To give the data a new or different filename or to change input file format:

- Select **File | Save As**. A dialog box appears.
- All files with COL extension contained in the current drive and directory are displayed in the FILE NAME list box.

- To save the file to a drive or directory other than the default, select a different drive from the Drives drop-down list or a different directory from the Directories list box.
- Use FILE TYPE list box to select either spColumn Input File (COL) or spColumn Text Input File (CTI).
- In the FILE NAME text box, type a new filename. If no file extension is specified, an extension will be appended to the specified filename based on the selected file type.
- Choose the OK button.

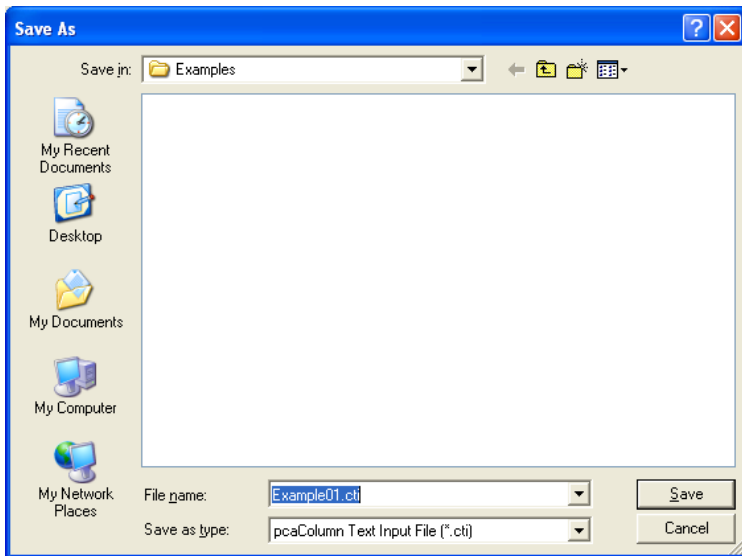

Importing Data

Geometry, reinforcement or load data may be imported from a text file. The import file must be saved in pure ASCII (text) format.⁵⁹

- Select **File | Import**. A dialog box appears.

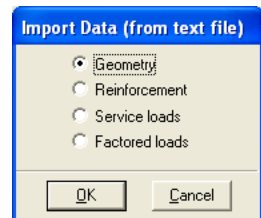

⁵⁹ See Appendix for description of the import file format

- Select the type of data you want to import: SERVICE LOADS, FACTORED LOADS, REINFORCEMENT OR GEOMETRY.
- Choose the OK button. The Open Import file box is displayed.
- All files with the TXT extension contained in the current drive and directory are displayed in the FILE NAME list box.
- To open a file that exists in another drive or directory, select the drive or directory you want from the Drives drop-down list or the Directories list box respectively.
- From the File Name list box, select the file to be opened, or simply type its name in the text box.
- Choose the OK button.

Exporting Data

Once a successful run has been performed you may export points from the interaction diagram or 3D failure surface to a Comma-Separated Values (CSV) file or to a Tab Delimited Text file (TXT). These files can be read by most spreadsheet and mathematical programs where data produced by spColumn can be further analyzed and processed as needed the user. Coordinates of the points (P , M_x , M_y) are saved together with corresponding location of the neutral axis (depth and angle), maximum steel strain, and (for ACI code) strength reduction factor. Also, the column section can be exported to a file in Drawing Exchange Format (DXF) format that is readable by most CAD programs.

- Select **File | Export | Current Interaction Diagram** to export P-M or M_x - M_y diagram currently displayed on the screen.
- To export 3D failure surface (biaxial runs only) select **File | Export | 3D Failure Surface**.
- To export column section to DXF file select **File | Export | Column Section to DXF**.
- For interaction diagrams and 3D failure surface, use FILE TYPE list box to select either Comma-Separated Values (CSV) file or Tab Delimited Text file (TXT). For sections, only DXF format is available.

- In the FILE NAME text box, type the filename. If no file extension is specified, an extension will be appended to the specified filename based on the selected file type.
- Choose the OK button.

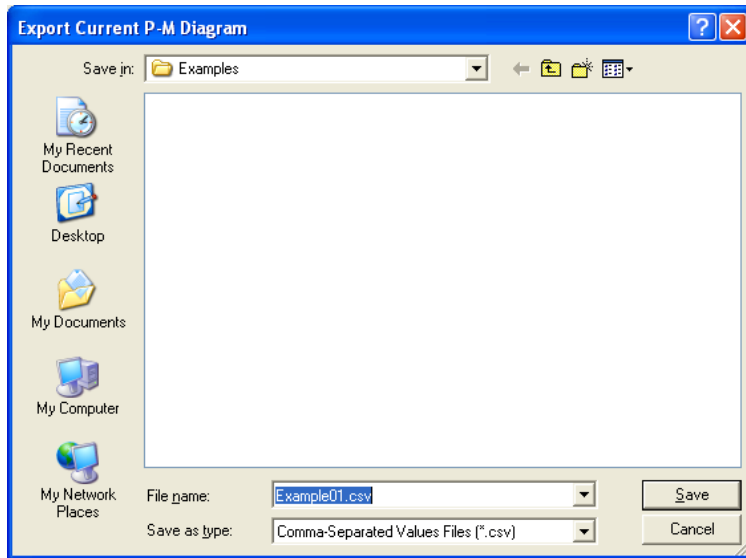

Printing the Results

Once a successful run has been performed you may print the displayed diagram using **File | Print Screen** command. if the **Solve | Results File** option was selected you may print the results file using **File | Print Results** . spColumn sends the printout to the printer selected in the Print dialog box.

- Select **File | Print Results or File | Print Screen**. A dialog box appears.
- Select the printer to send the results to.
- Use Print dialog controls to set up the printer options.
- Choose the OK button to start the printing or choose the CANCEL to terminate the print job.

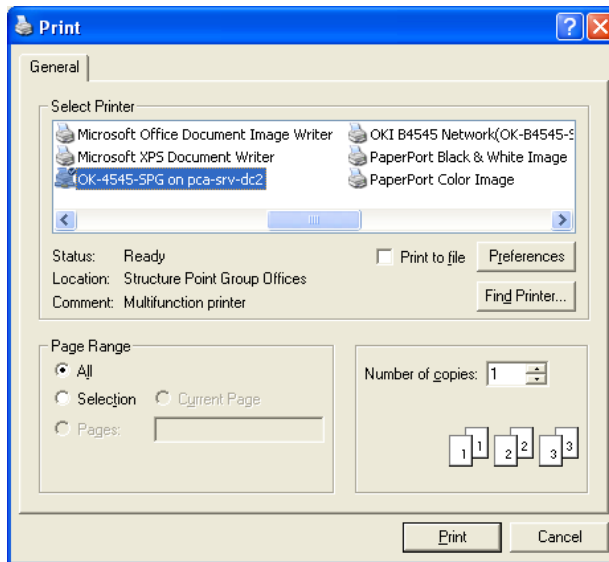

General Information

The General Information command allows you to define or change options that will affect the rest of the input.

- Select **Input | General Information**. A dialog box appears.
- Enter the PROJECT, COLUMN, and ENGINEER labels.
- Select the units of measure, ENGLISH or METRIC.
- Select the axis about which the column capacity is to be computed: ABOUT X-AXIS, ABOUT Y-AXIS, or BIAXIAL.
- Select the design code to conform to: ACI 318-05, ACI 318-02, CSA A23.3-04 or CSA A23.3-04.
- Choose a run option: INVESTIGATION or

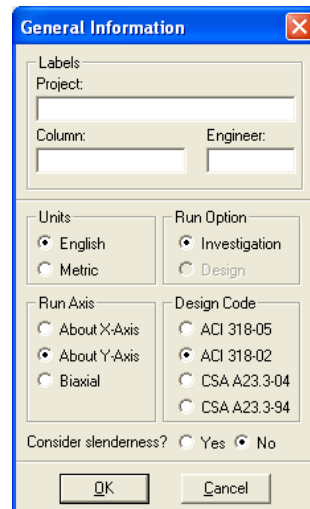

DESIGN.

- Specify whether slenderness effects are to be considered or not by checking either YES or NO under the CONSIDER SLENDERNESS? option.
- Choose the OK button.

Material Properties

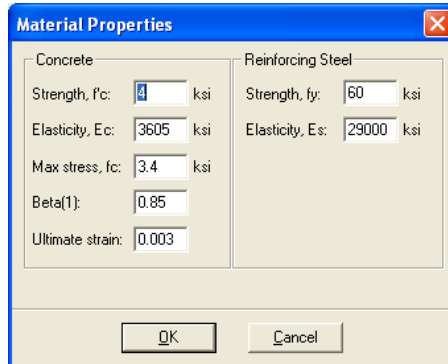

The image shows a dialog box titled "Material Properties" with a close button (X) in the top right corner. The dialog is divided into two main sections: "Concrete" and "Reinforcing Steel".

Concrete Section:

- Strength, f'_c : 4 ksi
- Elasticity, E_c : 3605 ksi
- Max stress, f_c : 3.4 ksi
- Beta(1): 0.85
- Ultimate strain: 0.003

Reinforcing Steel Section:

- Strength, f_y : 60 ksi
- Elasticity, E_s : 29000 ksi

At the bottom of the dialog, there are two buttons: "OK" and "Cancel".

- Select **Input | Material Properties**. A dialog box appears.
- Enter the concrete compressive strength, f'_c under STRENGTH, f'_c . The modulus of elasticity, E_c , under ELASTICITY, E_c ; the constant stress intensity, f_c at the maximum usable strain used to calculate the force on concrete, under MAX STRESS, f_c ; the factor used to determine the depth of the stress block, under BETA(1); and the maximum usable strain at the extreme concrete compression fiber, at the ULTIMATE STRAIN are automatically computed and displayed. Modify any of the values if different that computed.
- For the reinforcing steel, enter the yield strength, f_y under STRENGTH, f_y , and the modulus of elasticity, E_s under the ELASTICITY, E_s .
- Choose the OK button.

Section / Rectangular

Inputting for the Investigation Option:

- Select **Input | Section | Rectangular**. A dialog box appears.

- Enter the width and depth of the rectangular section using WIDTH (ALONG X) and DEPTH (ALONG Y) respectively. Note that width is measured along the x-axis and depth is measured along the y-axis.
- Choose the OK button.

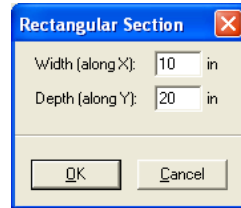

Inputting for the Design Option:

- Select **Input | Section | Rectangular**. A dialog box appears.
- Enter the starting and ending values for each dimension (width and depth) along with an increment for each dimension under START, END and INCREMENT columns along WIDTH (ALONG X) and DEPTH (ALONG Y). Note that the starting and ending values may be the same (in which case the increment must be zero).
- Choose the OK button.

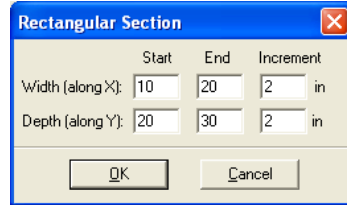

Section / Circular

Inputting for the Investigation Option:

- Select **Input | Section | Circular**. A dialog box appears.
- Enter the diameter of the column section.
- Choose the OK button.

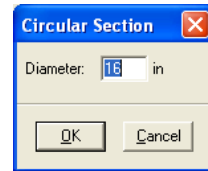

Inputting for the Design Option:

- Select **Input | Section | Circular**. A dialog box appears.
- Enter the starting and ending values the diameter along with an increment. Note that the starting and ending values may be the same (in which case the increment must be zero).
- Choose the OK button.

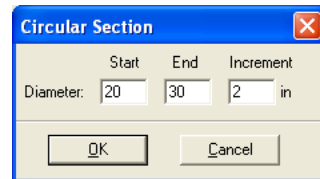

Reinforcement / All Sides Equal

The **Input | Reinforcement | All Sides Equal** command allows you to enter the total number of bars in the column section. The program attempts to divide the bars equally between the four sides of a rectangular layout then equally space them on each side. Corner bars are associated with the top and bottom sides, and if the total number of bars is not a multiple of four, the top and bottom sides get the extra bars. For a circular layout, the program attempts to equally space the bars.

Inputting for the Investigation Option:

- Select **Input | Reinforcement | All Sides Equal**. A dialog box appears.
- Enter the total number of bars in the section (must be at least 4 and must be a multiple of 4 for a rectangular layout). For a circular layout it could be any number greater than 4
- Select the bar size.
- Enter the clear cover and specify whether it is to the transverse (ties) or to the longitudinal bars.
- Select a bar layout, **CIRCULAR** or **RECTANGULAR**. The default is Circular for a circular section and Rectangular for a rectangular section.
- Choose the OK button.



Inputting for the Design Option

- Select **Input | Reinforcement | All Sides Equal**. A dialog box appears.
- Enter the minimum and maximum total number of bars in the section (must be at least 4 and must be a multiple of 4 for a rectangular layout).
- Select the minimum and maximum bar sizes along with the clear cover.

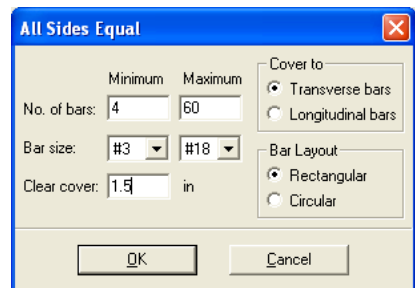

- Enter the clear cover and specify whether it is to the transverse (ties) or to the longitudinal bars.
- Select a bar layout, Circular or Rectangular. The default is Circular for a circular section and Rectangular for a rectangular section.

Reinforcement / Equal Spacing

The **Input | Reinforcement | Equal Spacing** command allows you to enter the total number of bars in the column section. The program attempts to place the bars equally spaced on all four sides of a rectangular layout. Corner bars are associated with the top and bottom sides and if the total number of bars is not a multiple of 4, the program does not accept the input.

Inputting for the Investigation Option:

- Select **Input | Reinforcement | Equal Spacing**. A dialog box appears.
- Enter the total number of bars in the section **NO. OF BARS**. (*Must be at least 4 and a multiple of 4*).
- Select the bar size.
- Enter the clear cover and specify whether it is to the transverse (ties) or to the longitudinal bars.
- Choose the OK button.

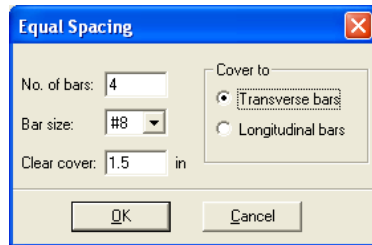

Inputting for the Design Option:

- Select **Input | Reinforcement | Equal Spacing**. A dialog box appears.
- Enter the minimum and maximum total number of bars in the section under **MINIMUM** and **MAXIMUM** corresponding to **NO. OF BARS**. (*must be a multiple of 4*).
- Select the minimum and maximum bar sizes.

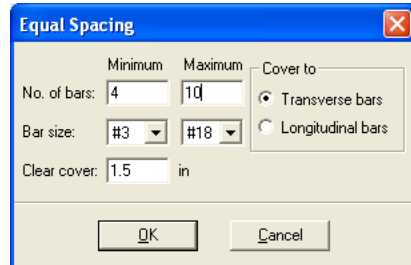

- Enter the clear cover and specify whether it is to the transverse (ties) or to the longitudinal bars.
- Choose the OK button.

Reinforcement / Sides Different

Inputting for the Investigation Option:

- Select **Input | Reinforcement | Sides Different**. A dialog box appears.
- Enter the number of bars to be placed on each of the top, bottom (on the top and bottom, number of bars needs to be at least 2), left and right sides (on the left and right, the number of bars may be any number) of the rectangular section. *Note that corner bars are associated with the top and bottom sides.*
- Select the bar size and enter the clear cover for each of the top, bottom, left and right sides of the section.
- Specify whether the clear cover entered is to the transverse (ties) or to the longitudinal bars.
- Choose the OK button.

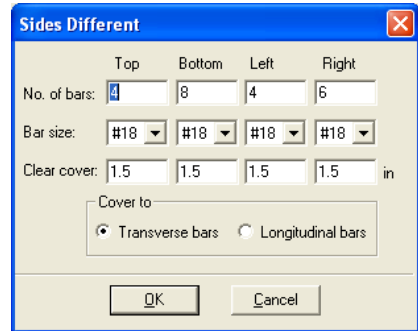

Inputting for the Design Option:

- Select **Input | Reinforcement | Sides Different**. A dialog box appears.
- In the Top and Bottom group, enter the minimum and maximum total number of bars to be placed on the top and bottom sides, along with the bar size and the clear cover. *The number of bars must be greater than 4 and a multiple of 2.*

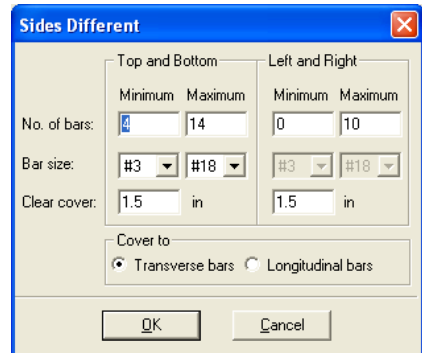

Corner bars are associated with the top and bottom sides.

- Select the minimum and maximum bar size and enter the clear cover.
- Repeat the steps above for the Left and Right sides.
- Specify whether the clear cover entered is to the transverse (ties) or to the longitudinal bars.
- Choose the OK button.

Reinforcement / Irregular Pattern

The **Input | Reinforcement | Irregular Pattern** command allows you to specify any number of bars (up to 10,000) to be placed anywhere within the column section. Each bar may have any cross-sectional area. *This command is available with the Investigation option only.*

- Select **Input | Reinforcement | Irregular Pattern**. If the section is irregular, The spSection window, where the section reinforcement may be graphically input, is displayed. Otherwise, a dialog box appears.
- Enter the bar area, along with its x- and y-coordinates.
- Choose the INSERT button. The data are added to the list box.
- Repeat the steps above for each entry.
- To edit an entry, select it from the list box, modify its values in the text boxes, and choose the MODIFY button. To change the area for several bars at once, select those bars from the list box, enter the new area in the AREA text box, and choose MODIFY.
- To delete a bar entry, select it from the list box and choose the DELETE button.
- Choose the OK button.

No.	Area	X	Y
1	4	-4.5	4.5
2	4	4.5	4.5
3	4	-4.5	-4.5
4	4	4.5	-4.5

Reinforcement / Confinement

- Select **Input | Reinforcement | Confinement**. A dialog box appears.
- Select the type of bar confinement: TIED (default), SPIRAL, or Other. The capacity reduction factors change depending on the selection.
- To modify the capacity reduction factors, choose OTHER for confinement type.

For the ACI code:

$\Phi(a)$ is the reduction factor for allowable compression,

$\Phi(b)$ is the strength reduction factor for tension controlled failure,

$\Phi(c)$ is the reduction factor for compression controlled failure.

For the CSA code:

$\Phi(a)$ is the reduction factor for allowable compression,

$\Phi(s)$ is the material resistance factor for steel,

$\Phi(c)$ is the material resistance factor for concrete.

- Specify the tie size associated with the particular longitudinal bar sizes. The code requirements are used as defaults.
- Choose the OK button.

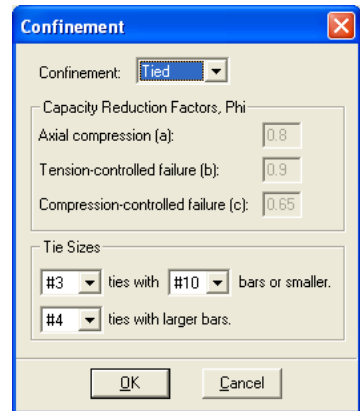

Reinforcement / Design Criteria

- Select **Input | Reinforcement | Design Criteria**. A dialog box appears. *This command is available with the Design option only.*
- Specify whether the column is to be considered STRUCTURAL (default), ARCHITECTURAL, or OTHER. Notice that the minimum and maximum reinforcement ratios change depending on the selection.
- Choose whether bar selection is to be based on MINIMUM NUMBER OF BARS (default) or on MINIMUM AREA OF STEEL.

- To modify the limiting reinforcement ratios, choose OTHER. Enter the minimum and maximum reinforcement ratios in the corresponding text boxes.
- Enter the minimum clear bar spacing and the design-to-required ratio.
- Choose the OK button.

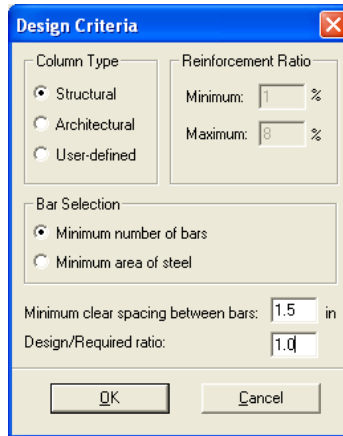

Slenderness / Factors

- Select **Input | Slenderness | Factors**. A dialog box appears. *Note: this command is available for slender columns only.*
- The default values, per the design code, for the stiffness reduction factor (used to compute the moment magnification factors) and the cracked section coefficients for beams and columns are displayed. To modify these values, select the User-defined option and enter your values.
- Choose the OK button.

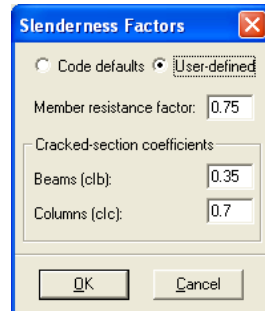

Slenderness / Design Column

- Select **Input | Slenderness | Design Column**. A dialog box appears. The x-axis or y-axis data groups may be disabled depending on the active run axis. *Note: this command is available for slender columns only.*
- Enter the clear column height in the corresponding text box.
- Specify whether the column is braced against sidesway or not by selecting or clearing the NON-SWAY option.
- For an sway column, enter the ratio of the sum of the critical load of all story columns to the critical load of the column under consideration, (SUM PC)/PC. Also, enter the ratio of the sum of the factored axial load of all story columns to the factored axial load of the column under consideration, (SUM PU)/PU.
- In the EFFECTIVE LENGTH FACTORS group, specify whether the k factor(s) are to be user-input or computed by the program, by selecting the corresponding option.
- If you chose Input k Factors, enter the effective length factors for nonsway and sway conditions, k(b) and k(s), respectively.
- Repeat the steps above for each active axis.
- Choose the OK button.

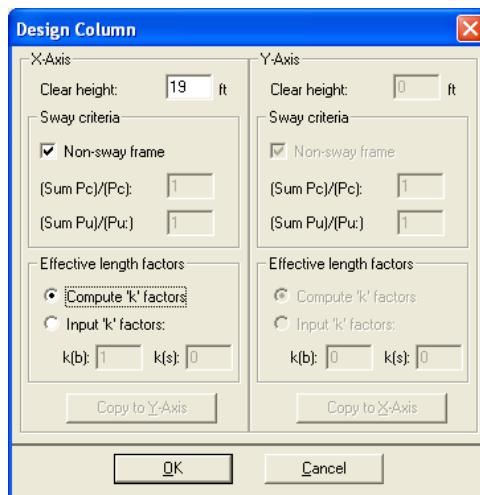

X-Axis		Y-Axis	
Clear height:	19 ft	Clear height:	0 ft
Sway criteria		Sway criteria	
<input checked="" type="checkbox"/> Non-sway frame		<input checked="" type="checkbox"/> Non-sway frame	
(Sum Pc)/(Pc):	1	(Sum Pc)/(Pc):	1
(Sum Pu)/(Pu):	1	(Sum Pu)/(Pu):	1
Effective length factors		Effective length factors	
<input checked="" type="radio"/> Compute 'k' factors		<input checked="" type="radio"/> Compute 'k' factors	
<input type="radio"/> Input 'k' factors:		<input type="radio"/> Input 'k' factors:	
k(b):	1	k(b):	0
k(s):	0	k(s):	0
Copy to Y-Axis		Copy to X-Axis	
OK		Cancel	

Slenderness / Columns Above and Below

- Select **Input | Slenderness | Columns Above/Below**. A dialog box appears. Note: this command is available for slender columns only for which the COMPUTE k FACTORS option is selected in the DESIGN COLUMN dialog box.

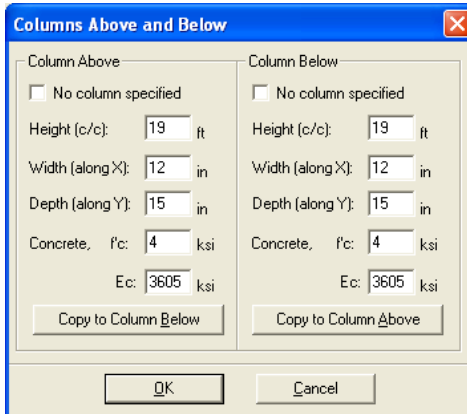

- In the COLUMN ABOVE group, specify whether or not a column above the design column exists, by selecting or clearing the NO COLUMN SPECIFIED OPTION.
- If a column above exists; enter the center-to-center height, the width (along the x-axis), the depth (along the y-axis), the concrete compressive strength, and the concrete modulus of elasticity of the column above in the corresponding text boxes. For circular sections, enter zero for the DEPTH and input the section diameter in the WIDTH box. If zero is entered for both Width and Depth, the dimensions of the design column will be automatically used.
- Repeat the same for the column below or, if the column above and the column below are the same, choose the COPY TO COLUMN BELOW button.
- Choose the OK button.

Slenderness / X-Beams

- Select **Input | Slenderness | X-Beams**. A dialog box appears. Beams defined using this command span perpendicular to the x-axis. Note: this command is available for slender columns only for which the COMPUTE K

FACTORS *option is selected in the DESIGN COLUMN dialog box and the RUN AXIS is BIAxIAL or uniaxial ABOUT X-AXIS.*

- From the BEAM LOCATION group, choose the appropriate option. The data group below updates depending on the selection.
- For the selected beam, specify whether or not a beam exists, by selecting or clearing the NO BEAM SPECIFIED OPTION.
- If a beam exists; enter the center-to-center span length, width, depth, concrete compressive strength, concrete modulus of elasticity, and moment of inertia (if different than computed) of the beam.
- Repeat the steps above for the beams ABOVE RIGHT, BELOW LEFT, and BELOW RIGHT.
- Choose the OK button.

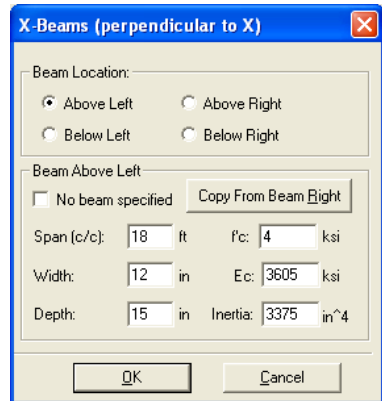

Slenderness / Y-Beams

- Select **Input | Slenderness | Y-Beams**. A dialog box appears. Beams defined using this command span perpendicular to the y-axis. *Note: this command is available for slender columns only for which the COMPUTE K FACTORS option is selected in the DESIGN COLUMN dialog box and the RUN AXIS is BIAxIAL or uniaxial ABOUT Y-AXIS.*
- From the BEAM LOCATION group, choose the appropriate option. The data group below updates depending on the selection.

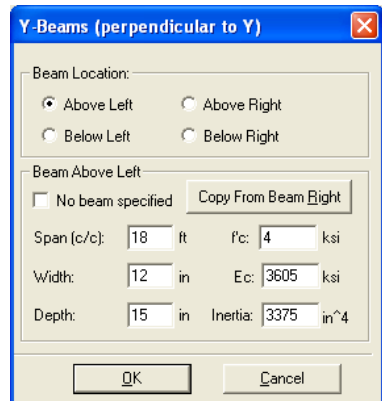

- For the selected beam, specify whether or not a beam exists, by selecting or clearing the NO BEAM SPECIFIED OPTION.
- If a beam exists; enter the center-to-center span length, width, depth, concrete compressive strength, concrete modulus of elasticity, and moment of inertia (if different than computed) of the beam.
- Repeat the steps above for the beams ABOVE RIGHT, BELOW LEFT, and BELOW RIGHT.
- Choose the OK button.

Loads / Factored

Whether designing or investigating a short (non-slender) column, factored loads consisting of applied axial loads and moments about the active axis may be input.

- Select **Input | Loads | Factored**. A dialog box appears.
- Enter the factored axial load in the LOAD text box.
- Depending on the active axis, enter the factored moment about the x-axis – X-MOMENT, the factored moment about the y-axis – Y-MOMENT, or both.
- Choose the INSERT button. The data are added to the list box.
- Repeat the steps above for each factored load entry.
- To edit an entry, select it from the list box, modify its values in the text boxes, and choose the MODIFY button.
- To delete an entry, choose it from the list box and choose the DELETE button.
- Choose the OK button.

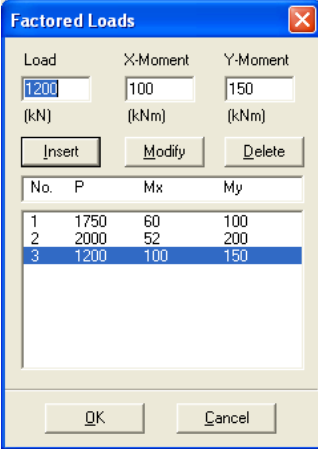

The dialog box titled "Factored Loads" contains three input fields: "Load (kN)" with value 1200, "X-Moment (kNm)" with value 100, and "Y-Moment (kNm)" with value 150. Below these are "Insert", "Modify", and "Delete" buttons. A table lists three entries, with the third entry selected:

No.	P	Mx	My
1	1750	60	100
2	2000	52	200
3	1200	100	150

At the bottom are "OK" and "Cancel" buttons.

Loads / Service

When designing or investigating a short or slender column, service level loads consisting of dead, live, lateral (wind and earthquake), and snow axial loads and moments at both column ends about the active axis may be input. These loads are then factored and combined based on the load combinations.

- Select **Input | Loads | Service**. A dialog box appears.

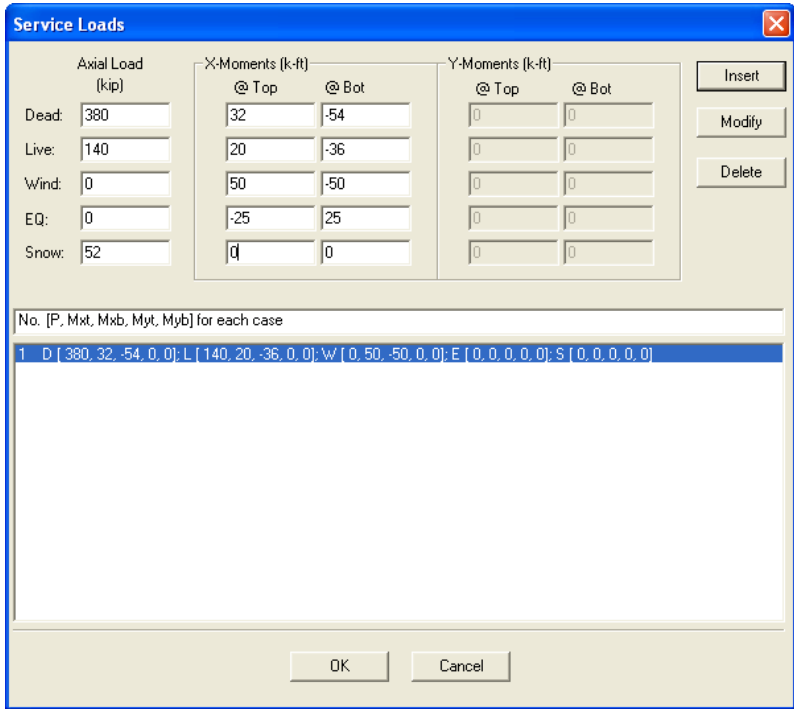

The dialog box titled "Service Loads" contains the following data:

	Axial Load (kip)	X-Moments (k-ft)		Y-Moments (k-ft)	
		@ Top	@ Bot	@ Top	@ Bot
Dead:	380	32	-54	0	0
Live:	140	20	-36	0	0
Wind:	0	50	-50	0	0
EQ:	0	-25	25	0	0
Snow:	52	0	0	0	0

Buttons: Insert, Modify, Delete, OK, Cancel

No. [P, Mxt, Mxb, Myt, Myb] for each case

1 D [380, 32, -54, 0, 0]; L [140, 20, -36, 0, 0]; W [0, 50, -50, 0, 0]; E [0, 0, 0, 0, 0]; S [0, 0, 0, 0, 0]

- For each of the load cases: dead, live, wind, earthquake, and snow, enter the axial load and the applicable moment (about x or y) at the column top and bottom.
- Choose the INSERT button. The data are added to the list box.
- Repeat the steps above for each entry.

- To edit an entry, select it from the list box, modify its values in the text boxes, and choose the MODIFY button.
- To delete an entry, choose it from the list box and choose the DELETE button.
- Choose the OK button.

Load / Control Points

A non-slender column may be investigated without inputting any loads. The capacity of the section is computed along with other important information. *This command is not available for slender columns or under the Design option.*

- Select **Input | Loads | Control Points**.

In the output file, key points on the interaction diagram are listed. For each point, the axial load and bending moment capacities, along with the corresponding neutral axis depth, are listed.

For a biaxial run, these points are listed for bending about positive and negative X and Y axes.

For a uniaxial runs, the bar-splice regions are indicated on the interaction diagram.

Loads / Axial Loads

When investigating a short column (uniaxial runs only), grouped factored applied axial loads may be input. The corresponding moment capacity for each load is computed and output. *This command is not available under the DESIGN option, for biaxial runs, or if the column is slender.*

- Select **Input | Loads | Axial Loads**. A dialog box appears.
- To input a range of axial loads, enter the initial, final and increment values in the corresponding text boxes. To input a discrete (single) axial load, enter its value in the INITIAL text box, and enter zero in the FINAL and INCREMENT text boxes.

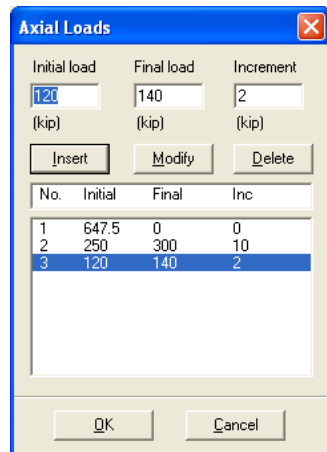

No.	Initial	Final	Inc
1	647.5	0	0
2	250	300	10
3	120	140	2

- Choose the INSERT button. The data are added to the list box.
- Repeat the steps above for each axial load entry you may have.
- To edit an entry, select it from the list box, modify its values in the text boxes, and choose the MODIFY button.
- To delete an entry, choose it from the list box and choose the DELETE button.
- Choose the OK button.

Loads / Load Combinations

spColumn allows you to specify up to 50 load combinations. The service load input under the load cases (dead, live, wind, earthquake, and snow) are combined based on these combinations. A minimum of one combination must be input.

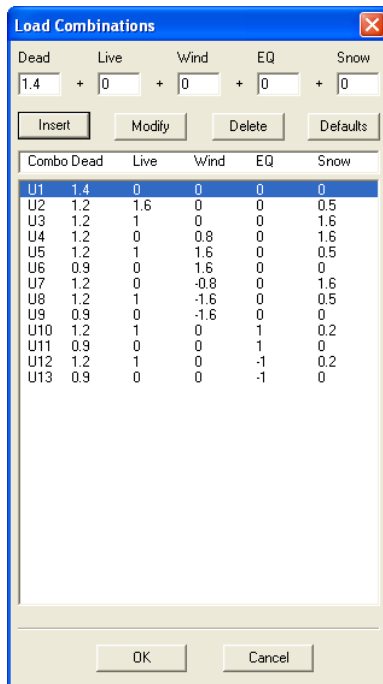

Combo	Dead	Live	Wind	EQ	Snow
U1	1.4	0	0	0	0
U2	1.2	1.6	0	0	0.5
U3	1.2	1	0	0	1.6
U4	1.2	0	0.8	0	1.6
U5	1.2	1	1.6	0	0.5
U6	0.9	0	1.6	0	0
U7	1.2	0	-0.8	0	1.6
U8	1.2	1	-1.6	0	0.5
U9	0.9	0	-1.6	0	0
U10	1.2	1	0	1	0.2
U11	0.9	0	0	1	0
U12	1.2	1	0	-1	0.2
U13	0.9	0	0	-1	0

defined.

- Select **Input | Loads | Load Combinations**. A dialog box appears. For a new file, the default combinations per the selected code are shown in the list box.
- To add a new combination, enter the load factors or multipliers for each load case, DEAD, LIVE, WIND, Earthquake (EQ), and SNOW.
- Choose the INSERT button. The data are added to the list box.
- Repeat the steps above for each load combination. Up to fifty combinations may be

- To edit an entry, select it from the list box, modify its values in the text boxes, and choose the MODIFY button.
- To delete an entry, choose it from the list box and choose the DELETE button.
- Choose OK when done.

Flipping / Rotating the Section

This command is available for Irregular sections and for sections with Sides Different or Irregular reinforcement.

- Select **Input | Flip/Rotate Section**. A dialog box appears.
- Select one of the options: FLIP SECTION ABOUT X-AXIS, FLIP SECTION ABOUT Y-AXIS, or ROTATE SECTION. The last option is available for irregular sections only.
- If ROTATE SECTION is selected, enter the angle of rotation (clockwise is positive).
- Choose the OK button.

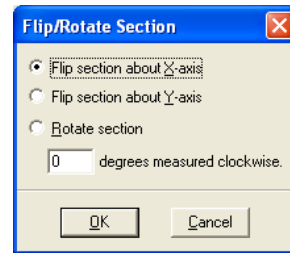

Executing a Run

From the program

- Select **Solve | Results File**. This is an option that may be turned ON or OFF by choosing it again. With this option ON, an output file will be created while the program is solving. The output file is a text file that contains an echo of the input along with slenderness calculation output, load combinations, and the critical points on the interaction diagram.
- Select **Solve | Design Trace** (*design option only*). This is an option that may be turned ON or OFF by choosing it again. With this option ON, if designing a column section, the program will pause at each cross section and reinforcement layout it tries, and display the cross section with its bars in the Information bar.
- Select **Solve | Execute**. If more data are needed to solve the problem, an error box appears and you will be prompted for the required data. If all the needed data are input, the solver portion of spColumn will start executing.

The Solving box appears with a progress indicator. Click Cancel to terminate the solution process. After a successful run, the interaction diagram or the contour plot is displayed in the Graphics area of the window.

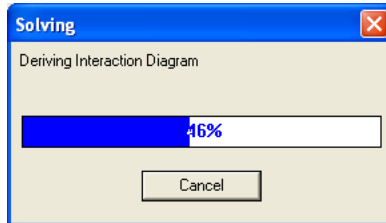

From command prompt

spColumn run can also be executed from the command line prompt. Input data file, output data file, and run options can be passed to the program via parameters. For instance typing `spColumn /i:Examples\Example01.col` will run spColumn and solve the column define in input file Example01.col.

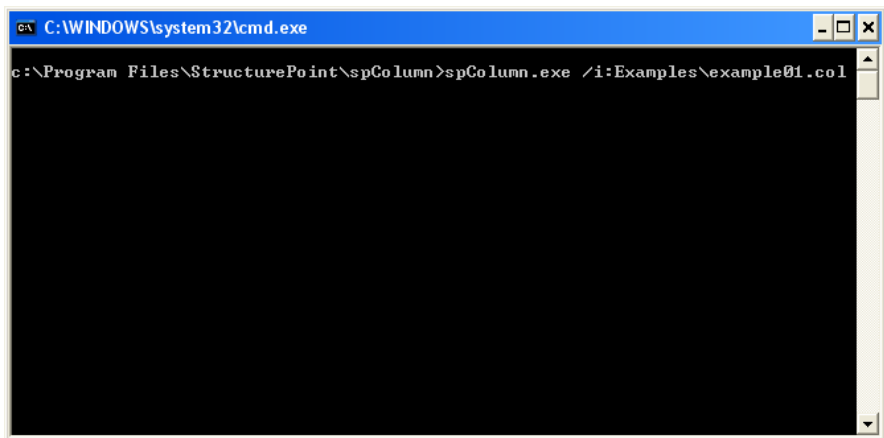

Help on how to use command line parameters can be obtained by typing `spColumn /?` at the command prompt.

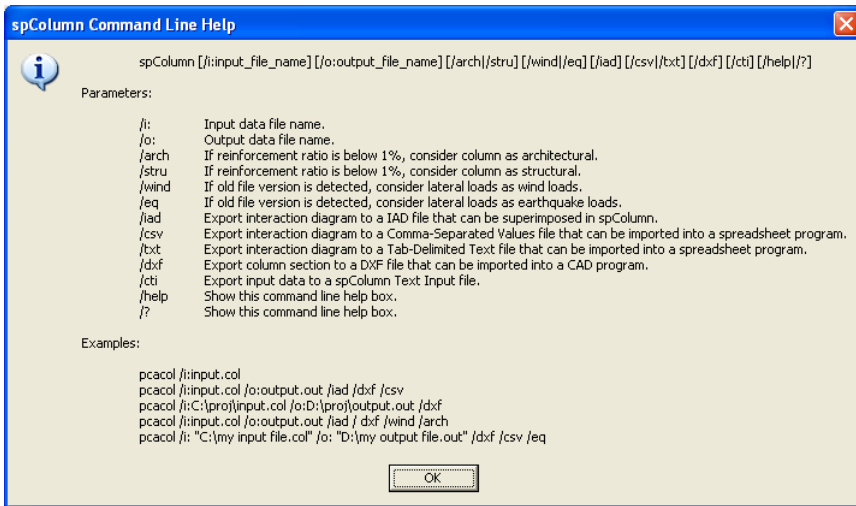

Viewing the Results

Once a successful run has been performed with the **Solve | Results File** option ON, you may view the results file.

- Select **View | Results**. spColumn executes the spView program, an applet that enables viewing of text-based files.
- Use the scroll bars or the cursor keys to navigate through the file.
- Select **Exit** to quit spView and return to spColumn. Changing the Startup Defaults

You can change some default settings that spColumn uses when it is started or when the **File | New** command is executed.

- Select **Options | Startup Defaults**. A dialog box appears.
- Enter the full path of the directory to which spColumn defaults when opening a data file.
- Select the system of units, design code, and reinforcement to be used as defaults

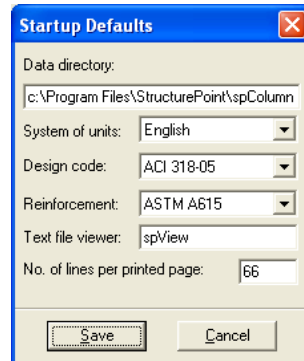

whenever a new file is started.

- Enter the name of the program to be used by spColumn when viewing results. By default, spColumn uses spView.
- Enter the number of lines per page to be used in formatting the results file.
- Choose the SAVE button to save these options in the registry.

Changing the Reinforcement Bar Set

- Select **Options | Reinforcement**. A dialog box appears.

To select a different set:

- From the BAR SET drop-down list, select the set to be used.
- Choose the OK button.

To create or modify a user-defined set

- From the BAR SET drop-down list, select USER-DEFINED. The ADD, DELETE and MODIFY buttons are enabled.
- To edit an entry, select it from the list box, modify its values, and choose the MODIFY button.
- To delete an entry, select it from the list box and choose the DELETE button.
- To add an entry, enter the bar size, diameter, area and unit weight in the corresponding text box, and choose the ADD button. The data are added to the list box.
- A user-defined set may be saved to disk for use in other files. To do so, choose the SAVE button after inputting the bars. The bar set is saved to the file specified by the user. To retrieve a saved set, choose the READ button.
- Choose the OK button.

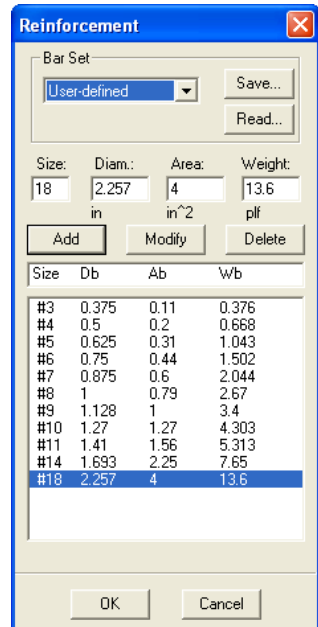

The dialog box titled "Reinforcement" contains a "Bar Set" dropdown menu currently set to "User-defined". Below the dropdown are "Save...", "Read...", "Add", "Modify", and "Delete" buttons. A table lists bar sets with columns for Size, Db, Ab, and W/b. The entry for Size 18 is highlighted.

Size	Db	Ab	W/b
#3	0.375	0.11	0.376
#4	0.5	0.2	0.668
#5	0.625	0.31	1.043
#6	0.75	0.44	1.502
#7	0.875	0.6	2.044
#8	1	0.79	2.67
#9	1.128	1	3.4
#10	1.27	1.27	4.303
#11	1.41	1.56	5.313
#14	1.693	2.25	7.65
#18	2.257	4	13.6

At the bottom of the dialog are "OK" and "Cancel" buttons.

Superimposing Diagrams

After executing a run and selecting the **File | Save** command, the program saves the diagram data in a separate file that has the same filename as the input file, with an IAD extension. This file may be later read by the program and two diagrams (of different files) may be superimposed for the purpose of comparison. Note that the RUN AXIS (uniaxial or biaxial) of the two files must be the same

- Select **View | Superimpose**. The open dialog box appears.
- All files with the IAD extension contained in the current drive and directory are displayed in the File Name list box. To open a file that exists in another drive or directory, select the drive or directory you want from the DRIVES drop-down list or the Directories list box respectively.
- From the FILE NAME list box, select the file to be opened, or simply type its name in the text box.
- Choose the OK button. If the data is successfully read, the diagram from the IAD file (shown dotted) is superimposed over the currently displayed diagram.
- To clear any superimposed diagrams, select the **View | Redraw** command.

Viewing the Diagram

For a uniaxial run, the program computes and displays the P-M interaction diagram. For a biaxial run, the program computes the three-dimensional failure surface (P, M_x, M_y). The failure surface can be viewed in one of two ways:

- a) P-M interaction diagram (vertical slice at an angle measured from M_x)
- b) M_x-M_y contour curve (horizontal slice at a constant axial load).

Whenever the mouse cursor moves over the Graph area, the axial load, moment, and eccentricity are displayed in the Status bar.

Viewing the Interaction Diagram

- Select **View | P-M Diagram - Full**. A dialog box appears.
- You may also select **View | P-M Diagram – M positive** or **View | P-M Diagram – M negative** to view the interaction diagram only for positive or negative moments.

- Specify whether you want to enter an angle or the values of the moments that produce a view angle by selecting either the **ANGLE** or **MOMENTS** option, respectively.
- If the **ANGLE** option was selected, select an angle from the list, use the scroll bar to pick an angle, or simply enter the value in the text box.
- If the **MOMENTS** option was selected, enter the values of M_x and M_y which define the view angle. The value of that view angle is computed and shown in the **ANGLE** text box.
- Choose the **OK** button.
- You may browse through the angles by using **View | Next angle** and **View | Previous angle** respectively.

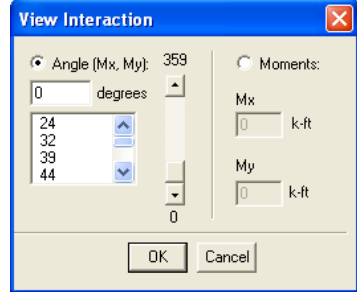

Viewing the Contour

- Select **View | Mx-My Diagram**. A dialog box appears.
- Select an axial load from the list, use the scroll bar to pick a load, or simply enter the value in the text box.
- Choose the **OK** button.
- You may browse through the loads by using **View | Next Load** and **View | Previous Load** respectively.

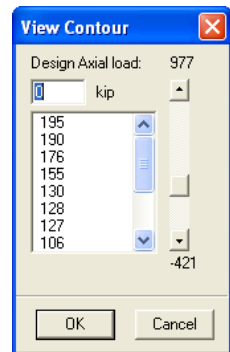

Chapter 5

Examples

Example 1 – Capacity of a Square Column

For a column section⁶⁰ which is 16" x 16" and reinforced with 4-#8 bars, calculate the load moment capacities for the following load conditions:

Case 1: Bar stress near tension face of member equal to zero, ($f_s = 0$).

Case 2: Bar stress near tension face of member equal to $0.5f_y$, ($f_s = 0.5f_y$)

Case 3: At limit for compression controlled sections. ($\epsilon_s = 0.002$)

Case 4: At limit for tension controlled sections. ($\epsilon_s = 0.005$)

Given a concrete of 4000 psi and reinforcing steel of 60,000 psi.

1. From the **File** menu, choose **New**. Any input data is cleared and the default values are restored.
2. From the **Input** menu, choose **General Information**.
 - Input the PROJECT header.
 - Select ENGLISH UNITS and ACI 318-05 code.
 - Select ABOUT X-AXIS for run axis, INVESTIGATION for RUN OPTION and NO for CONSIDER SLENDERNESS?
 - Choose Ok.
3. From the **Input** menu, choose **Material Properties**.

The screenshot shows the 'General Information' dialog box. The 'Project' field is 'Manual Example 1', 'Column' is 'PCANotes 6.4', and 'Engineer' is 'SP'. Under 'Units', 'English' is selected. Under 'Run Option', 'Investigation' is selected. Under 'Run Axis', 'About X-Axis' is selected. Under 'Design Code', 'ACI 318-05' is selected. The 'Consider slenderness?' checkbox is checked, and 'No' is selected. The 'OK' and 'Cancel' buttons are at the bottom.

⁶⁰ Based on Example 6.4, pp 6-34 from Notes on ACI 318-05 Building Requirements for Structural Concrete with Design Applications, Ninth Edition, 2005, Portland Cement Association.

- Accept the default properties as they match those in the problem statement
- Choose OK.

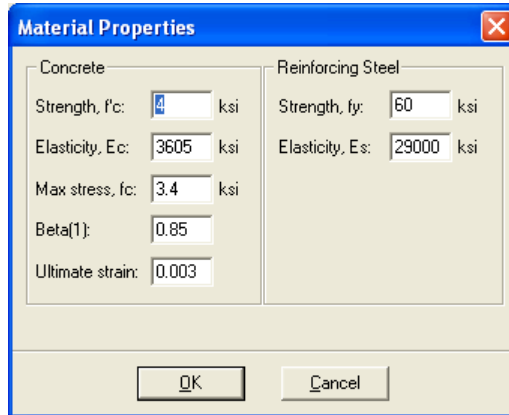

4. From the **Input** menu, choose **Section | Rectangular**.

- For the section WIDTH (ALONG X), input 16
- For the section DEPTH (ALONG Y), input 16.
- Choose OK.

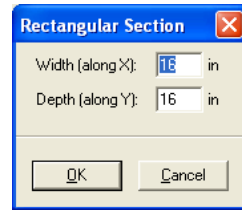

5. From the **Input** menu, choose **Reinforcement | Equal Spacing**.

- Input 4 – #8 bars under NO. OF BARS.
- Input 1.5 in for the CLEAR COVER and select TRANSVERSE BARS. under COVER TO.
- Choose OK.



6. From the **Input** menu, choose **Loads | Control Points**.
7. From the **Solve** menu, choose **Execute**.
 - The $P-M_x$ contour is displayed in the Graphics area.
8. From the **View** menu, choose **Results**.
 - Page through the results file.
 - Choose **File | Exit** to quit the spView program and get back to spColumn.
9. From the **File** menu, choose **Print Results**.
 - Select the printer to send the text results to.
 - Choose OK.
10. From the **File** menu, choose **Print Screen**.
 - Select the printer to send the graphical results to.
 - Choose OK.

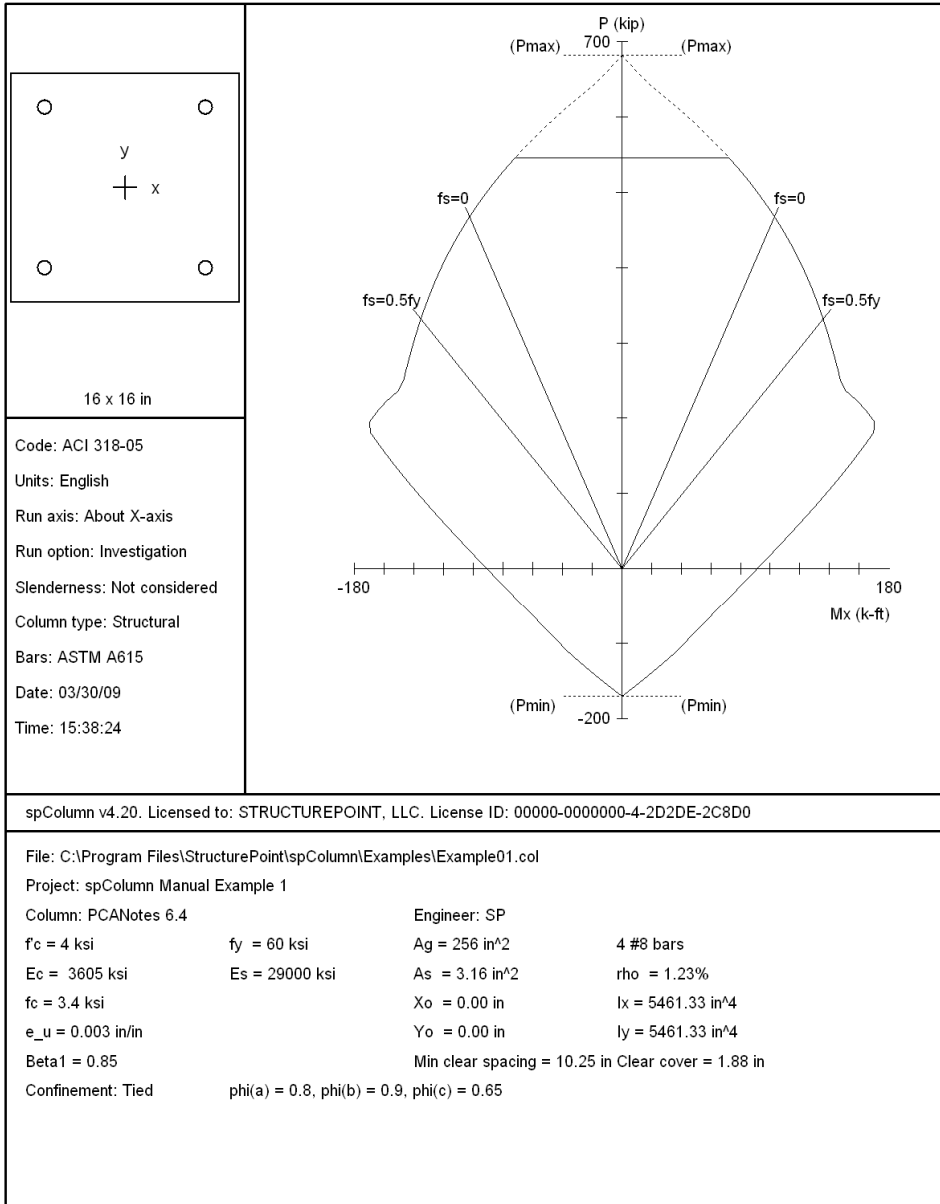

STRUCTUREPOINT - spColumn v4.20 (TM)
 Licensed to: STRUCTUREPOINT, LLC. License ID: 00000-0000000-4-2D2DE-2C8D0
 C:\Program Files\StructurePoint\spColumn\Examples\Example01.col

Page 2
 03/30/09
 03:38 PM

General Information:

```

=====
File Name: C:\Program Files\StructurePoint\spColumn\Examples\Example01.col
Project:   spColumn Manual Example 1
Column:   PCANotes 6.4                Engineer: SP
Code:     ACI 318-05                  Units: English

Run Option: Investigation              Slenderness: Not considered
Run Axis:  X-axis                      Column Type: Structural
  
```

Material Properties:

```

=====
f'c = 4 ksi                fy = 60 ksi
Ec = 3605 ksi             Es = 29000 ksi
Ultimate strain = 0.003 in/in
Beta1 = 0.85
  
```

Section:

```

=====
Rectangular: Width = 16 in          Depth = 16 in

Gross section area, Ag = 256 in^2
Ix = 5461.33 in^4                  Iy = 5461.33 in^4
Xo = 0 in                          Yo = 0 in
  
```

Reinforcement:

```

=====
Bar Set: ASTM A615
Size Diam (in) Area (in^2)  Size Diam (in) Area (in^2)  Size Diam (in) Area (in^2)
-----
# 3      0.38      0.11  # 4      0.50      0.20  # 5      0.63      0.31
# 6      0.75      0.44  # 7      0.88      0.60  # 8      1.00      0.79
# 9      1.13      1.00  # 10     1.27      1.27  # 11     1.41      1.56
# 14     1.69      2.25  # 18     2.26      4.00
  
```

Confinement: Tied; #3 ties with #10 bars, #4 with larger bars.
 phi(a) = 0.8, phi(b) = 0.9, phi(c) = 0.65

Layout: Rectangular
 Pattern: All Sides Equal (Cover to transverse reinforcement)
 Total steel area: As = 3.16 in² at rho = 1.23%
 4 #8 Cover = 1.5 in

Control Points:

```

=====

```

	Axial Load P kip	X-Moment k-ft	Y-Moment k-ft	N.A. depth in	eps_t	Phi
Bending about						
X @ Max compression	682.0	0.00	0.00	43.90	-0.00207	0.650
@ Allowable comp.	545.6	72.20	0.00	15.81	-0.00041	0.650
@ fs = 0.0	467.6	102.64	0.00	13.63	-0.00000	0.650
@ fs = 0.5*fy	331.8	135.43	0.00	10.13	0.00103	0.650
@ Balanced point	238.9	148.49	0.00	8.06	0.00207	0.650
@ Tension Control	188.7	172.04	0.00	5.11	0.00500	0.900
@ Pure bending	-0.0	91.03	0.00	2.24	0.01528	0.900
@ Max tension	-170.6	-0.00	-0.00	0.00	9.99999	0.900
-X @ Max compression						
@ Allowable comp.	545.6	-72.20	-0.00	15.81	-0.00041	0.650
@ fs = 0.0	467.6	-102.64	0.00	13.63	0.00000	0.650
@ fs = 0.5*fy	331.8	-135.43	0.00	10.13	0.00103	0.650
@ Balanced point	238.9	-148.49	0.00	8.06	0.00207	0.650
@ Tension Control	188.7	-172.04	-0.00	5.11	0.00500	0.900
@ Pure bending	-0.0	-91.03	-0.00	2.24	0.01528	0.900
@ Max tension	-170.6	-0.00	-0.00	0.00	9.99999	0.900

*** End of output ***

Example 2 – Investigation of a slender Non-Sway Column

Determine the adequacy of a 4" x 20" column⁶¹ with 3-#11 bars on each 14" side in a nonsway frame with a clear height of 22'6". Use $k=1.0$.

The concrete used is 6000 psi and the reinforcing steel is 60,000 psi.

The factored load values for the column under consideration are as follows:

P (kip)	115 kips
Top M_{wy} (kip-ft)	279 ft-kips
Bottom M_{wy} (kip-ft)	-279 ft-kips

From the **File** menu, choose **New**. Any input data is cleared and the default values are restored.

1. From the **Input** menu, choose **General Information**.

- Input the PROJECT header.
- Select ENGLISH units and ACI 318-05 code.
- Select BIAXIAL for RUN AXIS, INVESTIGATION for RUN OPTION and YES for CONSIDER SLENDERNESS?.
- Choose OK.

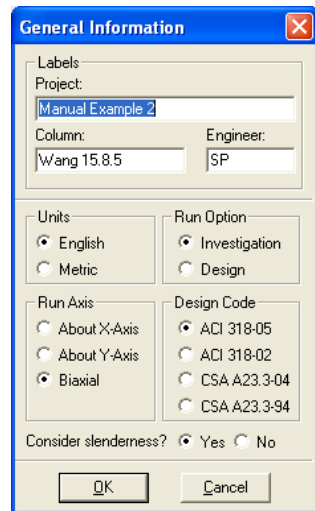

⁶¹ Based on Example 15.8.5 from Reinforced Concrete Design, by Wang, Salmon and Pincheira, Seventh Edition, 2007, John Wiley and Sons, Inc.

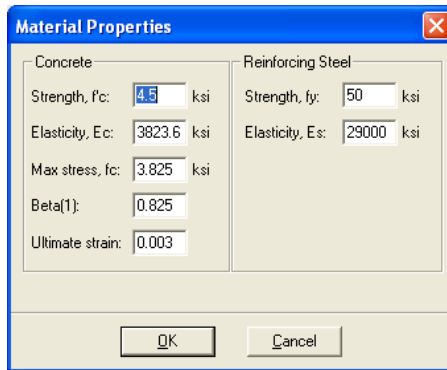

Material Properties

Concrete	Reinforcing Steel
Strength, f _c : 4.5 ksi	Strength, f _y : 50 ksi
Elasticity, E _c : 3823.6 ksi	Elasticity, E _s : 29000 ksi
Max stress, f _c : 3.825 ksi	
Beta(1): 0.825	
Ultimate strain: 0.003	

OK Cancel

- From the **Input** menu, choose **Material Properties**.
 - Input 4.5 for the CONCRETE STRENGTH. Change the REINFORCING STEEL STRENGTH to 50. Other properties are computed and will be accepted.
 - Choose Ok.

From the **Input** menu, choose **Section | Rectangular**.

- Input 20 and 14 for the SECTION WIDTH (ALONG X) and DEPTH (ALONG Y).
- Choose Ok.

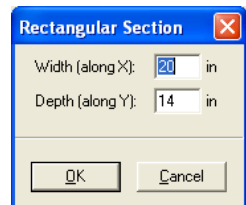

Rectangular Section

Width (along X): 20 in

Depth (along Y): 14 in

OK Cancel

- From the **Input** menu, choose **Reinforcement | Sides Different**.

- Input 2-#11 bars for TOP and BOTTOM and 1-#11 for LEFT and RIGHT. Input 1.5 in for the cover and select LONGITUDINAL BARS.
- Choose Ok.



Sides Different

	Top	Bottom	Left	Right
No. of bars:	2	2	1	1
Bar size:	#11	#11	#11	#11
Clear cover:	2.005	2.005	2.005	2.005 in

Cover to
 Transverse bars Longitudinal bars

OK Cancel

4. From the **Input** menu, choose **Slenderness | Design Column**.

- Input 22.5 for the column CLEAR HEIGHT.
- Check NON-SWAY frame against SWAY CRITERIA and select INPUT 'K' FACTORS.
- Choose OK.

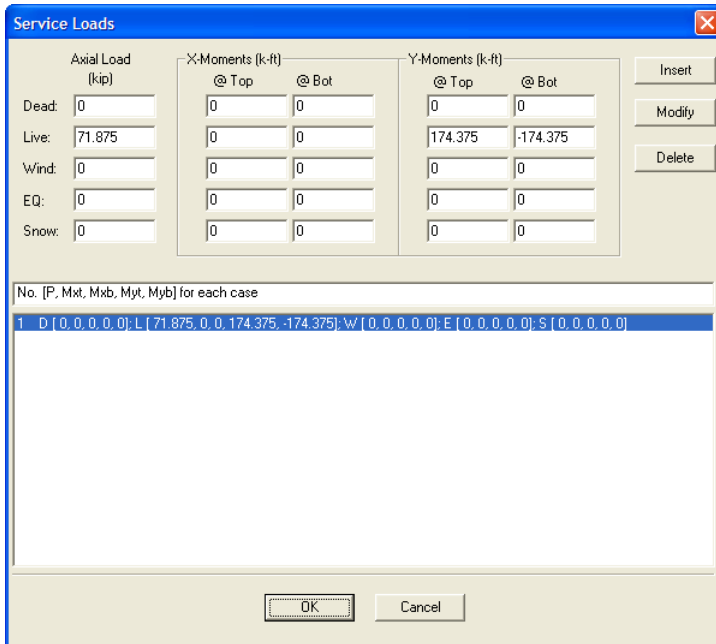
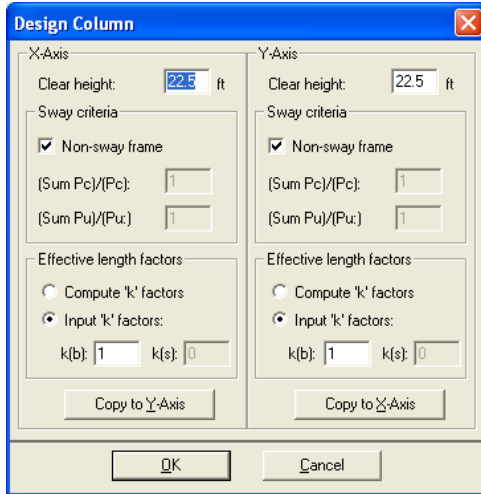

5. From the **Input** menu, choose **Loads | Service**.

- Under LIVE, input 71.875 for the AXIAL LOAD, 0 for the X-MOMENTS @TOP, 0 for the X-MOMENTS @BOT, 174.375 for the Y-MOMENTS @TOP and -174.375 for the Y-MOMENTS @BOTTOM, respectively.
 - Choose Insert to add the entry to the list box.
 - Choose Ok.
6. From the **Input** menu, choose **Loads | Load Combinations**.
 - If the list displays thirteen combinations, choose only the second load combination U2 and delete all the others by selecting them and using DELETE. Choose OK.
 7. From the **Solve** menu, choose **Execute**.
 - The solver of the program is started and, upon completion, displays the interaction diagram of the section with the load point plotted within the diagram.
 8. From the **View** menu, choose **Results**.
 - Page through the results file.
 - Choose FILE | EXIT to quit the spView program and get back to spColumn.
 9. From the **File** menu, choose **Print Results**.
 - Select the printer to send the text results to.
 - Choose Ok.
 10. From the **File** menu, choose **Print Screen**.
 - Select the printer to send the graphical results to.
 - Choose OK.

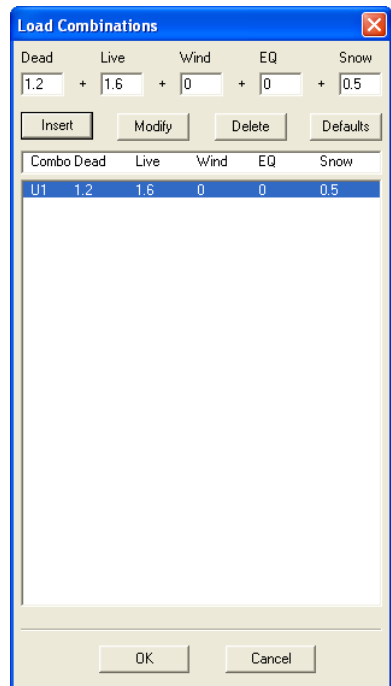

General Information:

```

=====
File Name: C:\Program Files\StructurePoint\spColumn\Examples\Example02.col
Project:  spColumn Manual Example 2
Column:  Wang15.18.5
Code:    ACI 318-05
Engineer: SP
Units:  English

Run Option: Investigation
Run Axis:  Biaxial
Slenderness: Considered
Column Type: Structural
  
```

Material Properties:

```

=====
f'c = 4.5 ksi
Ec = 3823.68 ksi
Ultimate strain = 0.003 in/in
Beta1 = 0.825

fy = 50 ksi
Es = 29000 ksi
  
```

Section:

```

=====
Rectangular: Width = 20 in
Depth = 14 in

Gross section area, Ag = 280 in^2
Ix = 4573.33 in^4
Iy = 9333.33 in^4
Xo = 0 in
Yo = 0 in
  
```

Reinforcement:

```

=====
Bar Set: ASTM A615
Size Diam (in) Area (in^2) Size Diam (in) Area (in^2) Size Diam (in) Area (in^2)
-----
# 3 0.38 0.11 # 4 0.50 0.20 # 5 0.63 0.31
# 6 0.75 0.44 # 7 0.88 0.60 # 8 1.00 0.79
# 9 1.13 1.00 # 10 1.27 1.27 # 11 1.41 1.56
# 14 1.69 2.25 # 18 2.26 4.00
  
```

Confinement: Tied; #3 ties with #11 bars, #4 with larger bars.
 phi(a) = 0.8, phi(b) = 0.9, phi(c) = 0.65

Layout: Rectangular
 Pattern: Sides Different (Cover to longitudinal reinforcement)
 Total steel area: As = 9.36 in² at rho = 3.34%

	Top	Bottom	Left	Right
Bars	2 #11	2 #11	1 #11	1 #11
Cover(in)	2.005	2.005	2.005	2.005

Slenderness:

```

=====
Sway Criteria:
-----
X-axis: Non-sway column.
Y-axis: Non-sway column.
  
```

STRUCTUREPOINT - spColumn v4.20 (TM)
 Licensed to: STRUCTUREPOINT, LLC. License ID: 00000-0000000-4-2D2DE-2C8D0
 C:\Program Files\StructurePoint\spColumn\Examples\Example02.col

Page 3
 03/30/09
 03:47 PM

Column Axis	Height ft	Width in	Depth in	I in ⁴	f'c ksi	Ec ksi
Design X	22.5	20	14	4573.33	4.5	3823.68
Y	22.5	20	14	9333.33	4.5	3823.68
Above X	(no column specified...)					
Y	(no column specified...)					
Below X	(no column specified...)					
Y	(no column specified...)					

X-Beams Location	Length ft	Width in	Depth in	I in ⁴	f'c ksi	Ec ksi
Above Left	(no beam specified...)					
Above Right	(no beam specified...)					
Below Left	(no beam specified...)					
Below Right	(no beam specified...)					

Y-Beams Location	Length ft	Width in	Depth in	I in ⁴	f'c ksi	Ec ksi
Above Left	(no beam specified...)					
Above Right	(no beam specified...)					
Below Left	(no beam specified...)					
Below Right	(no beam specified...)					

Effective Length Factors:

Axis	Psi (top)	Psi (bot)	k (Non-sway)	k (Sway)	klu/r
X	0.000	0.000	1.000	(N/A)	66.81
Y	0.000	0.000	1.000	(N/A)	46.77

Moment Magnification Factors:

Member resistance factor, phi(K) = 0.75
 Cracked-section coefficients: cI (beams) = 0.35; cI (columns) = 0.7
 0.2*Ec*Ig + Es*Ise (X-axis) = 6.83e+006 kip-in²
 0.2*Ec*Ig + Es*Ise (Y-axis) = 2.16e+007 kip-in²

X-axis		Non-sway				Sway	
Ld/Comb	Pc (kip)	Betad	Cm	Delta	Pc (kip)	Delta	
1 U1	924	0.000	1.000	1.199	N/A	---	

Y-axis		Non-sway				Sway	
Ld/Comb	Pc (kip)	Betad	Cm	Delta	Pc (kip)	Delta	
1 U1	2919	0.000	1.000	1.055	N/A	---	

Load Combinations:

U1 = 1.200*Dead + 1.600*Live + 0.000*Wind + 0.000*EarthQuake + 0.000*Snow

Service Loads:

Load No.	Case	Axial Load kip	Mx @ Top k-ft	Mx @ Bot k-ft	My @ Top k-ft	My @ Bot k-ft
1	Dead	0.00	0.00	0.00	0.00	0.00
	Live	71.88	0.00	0.00	174.38	-174.38
	Wind	0.00	0.00	0.00	0.00	0.00
	EQ	0.00	0.00	0.00	0.00	0.00
	Snow	0.00	0.00	0.00	0.00	0.00

Factored Loads and Moments with Corresponding Capacities:

=====

NOTE: Each loading combination includes the following cases:
 First line - at column top
 Second line - at column bottom

No.	Load Combo	Pu kip	Mux k-ft	Muy k-ft	fMnx k-ft	fMny k-ft	fMn/Mu	Phi
1	1 U1	115.00	11.72	294.47	13.39	336.38	1.142	0.900
2		115.00	11.72	294.47	13.39	336.38	1.142	0.900

*** End of output ***

Example 3 – Design of a Slender Column in a Sway Frame

Design a square column⁶² with a clear height of 16 ft. The column is sway and subjected to dead, live and wind loads as shown below.

	<u>Dead</u>	<u>Live</u>	<u>Wind</u>
P (kip)	380	140	0
Top M_x (kip-ft)	32	20	50
Bottom M_x (kip-ft)	54	36	50

The column is to be checked for the following load combinations:

$$U1 = 1.2 D + 1.6 L$$

$$U2 = 1.2 D + 0.5 L + 1.6 W$$

The calculations in the reference are done based on the load combination U2.

In practice, the ratio $\Sigma P_u/P_c$ would have to be calculated before the problem can be attempted, using a trial value of $\Sigma P_u/P_c$. Here, the value of $\Sigma P_u/P_c$ used is 28.67 based on the reference value of P_c . There are 14 interior columns, 18 exterior columns and 4 corner columns. Therefore, the value of $\Sigma P_u/P_u = 14 + 18 * 2/3 + 4 * 1/3 = 27.33$ irrespective of the load combination being used.

- From the **File** menu, choose **New**. Any input data is cleared and the default values are restored.
- From the **Input** menu, choose **General Information**.
 - Input the PROJECT header.
 - Select English units and ACI 318-02 code.

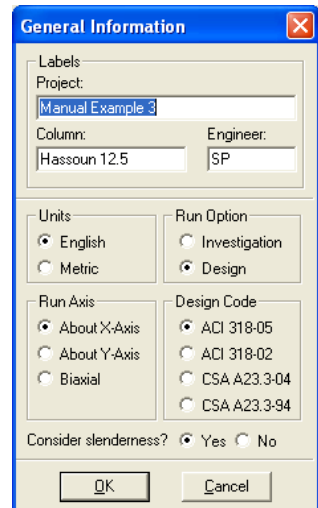

⁶² Based on Example 12.5, pp 405, from Structural Concrete: Theory and Design, by M.N.Hassoun and A. Al-Manaseer, Third Edition, 2005, John Wiley and Sons, Inc.

- Select ABOUT X-AXIS for RUN AXIS, DESIGN for RUN OPTION and YES for CONSIDER SLENDERNESS?
 - Choose OK.
3. From the **Input** menu, pick **Material Properties**.
- Input 5 for the concrete strength. Other properties are computed and will be accepted.
 - Choose OK.

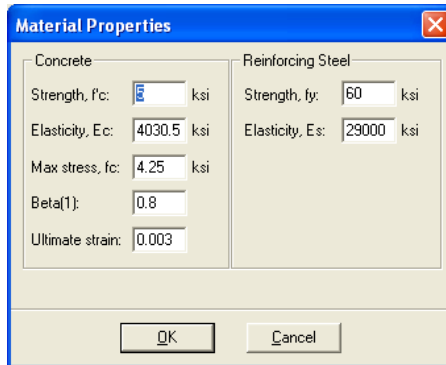

4. From the **Input** menu, pick **Section | Rectangular**.
- Input 18 and 18 for the WIDTH (ALONG X) and DEPTH (ALONG Y) under both START and END options.
 - Choose OK.

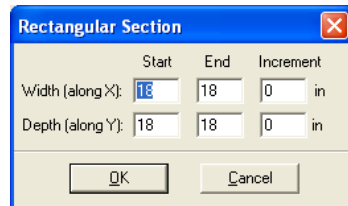

5. From the **Input** menu, choose **Reinforcement | Equal Spacing**.
- Input 8-#10 bars and 1.5 in for the cover and select TRANSVERSE BARS.
 - Choose OK.

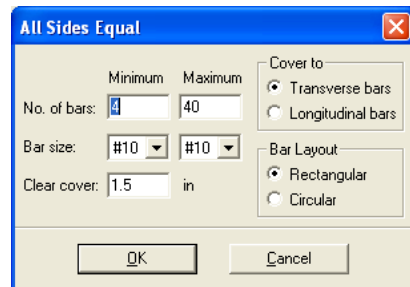

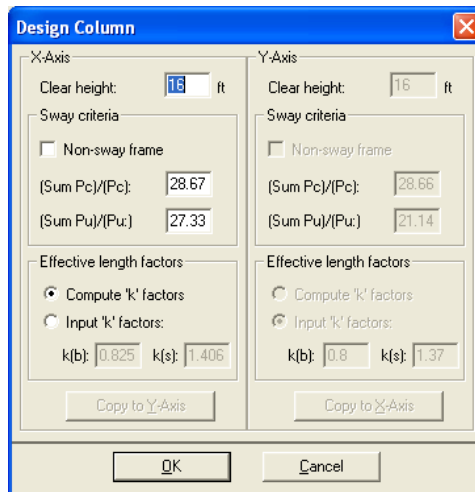

6. From the **Input** menu, choose **Slenderness | Design Column**.
 - Input 16 for the column CLEAR HEIGHT.
 - Check NON-SWAY FRAME under SWAY CRITERIA and input 28.67 and 27.33 for the $\Sigma P_c/P_c$ and $\Sigma P_u/P_u$, respectively.
 - Select COMPUTE 'K' FACTORS.
 - Choose OK.

7. From the **Input** menu, choose **Slenderness | Columns Above/Below**.
 - Clear the NO COLUMN SPECIFIED option.
 - Input 11 for the column height (center-to-center) under HEIGHT (C/C) and leave the other data as is.
 - Choose COPY TO COLUMN BELOW.
 - Choose Ok.

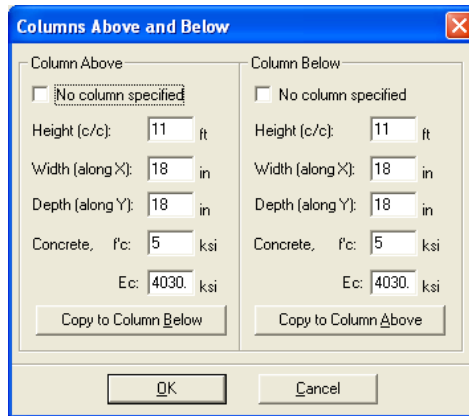

8. From the **Input** menu, choose **Slenderness | X-Beams**.

- Choose ABOVE LEFT.
- Clear the NO BEAM SPECIFIED option.
- Input 20 for the span (center-to-center) under SPAN(C/C).
- Input 0.00 and 0.00 for the WIDTH and DEPTH, respectively.
- Input 21436.6 for the moment of inertia under INERTIA.
- Leave the other data as it is.

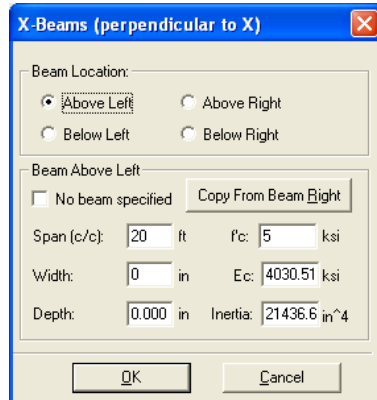

- Choose ABOVE RIGHT and click on COPY FROM BEAM LEFT.
- Choose BELOW LEFT and click on COPY FROM BEAM ABOVE.
- Choose BELOW RIGHT and click on COPY FROM BEAM ABOVE.
- Choose OK.

9. From the **Input** menu, choose **Loads | Service**.

- Under DEAD, input 380, 32 and -54 for the AXIAL LOAD, X-MOMENTS and Y-MOMENTS respectively.

- Under LIVE, input 140, 20 and -36 for the AXIAL LOAD, X-MOMENTS and Y-MOMENTS, respectively.
- Under WIND, input 0, 50 and -50 for the AXIAL LOAD, X-MOMENTS and Y-MOMENTS, respectively.
- Choose INSERT to add the entry to the list box.
- Choose OK.

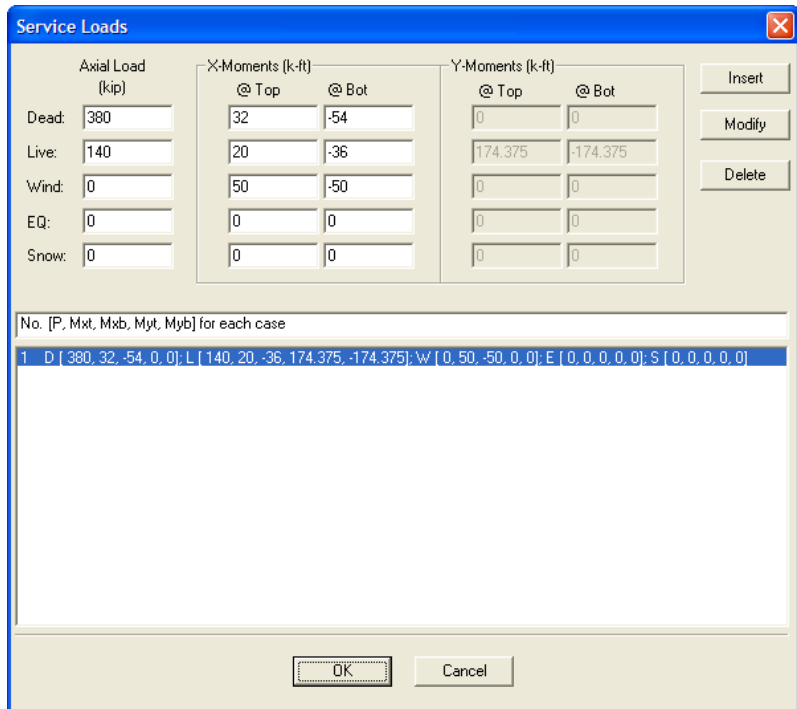

	Axial Load (kip)	X-Moments (k-ft)		Y-Moments (k-ft)	
		@ Top	@ Bot	@ Top	@ Bot
Dead:	380	32	-54	0	0
Live:	140	20	-36	174.375	-174.375
Wind:	0	50	-50	0	0
EQ:	0	0	0	0	0
Snow:	0	0	0	0	0

No. [P, Mxt, Mxb, Myt, Myb] for each case

1 D | 380, 32, -54, 0, 0; L | 140, 20, -36, 174.375, -174.375; W | 0, 50, -50, 0, 0; E | 0, 0, 0, 0, 0; S | 0, 0, 0, 0, 0

- From the **Input** menu, choose **Loads | Load Combinations**.
 - If the list displays thirteen combinations, leave the second as it is. Delete the remaining combinations using DELETE. Add the combination U2 = $1.2D + 0.5L + 1.6W$. Choose OK.
- From the **Solve** menu, choose **Execute**.
 - The solver of the program is started and, upon completion, displays the interaction diagram of the section with the load points plotted within the

diagram. Note that point 2 falls just outside the interaction diagram indicating inadequate capacity of this section.

12. From the **View** menu, choose **Results**.
 - Page through the results file.
 - Choose Exit to quit the spView program and get back to spColumn.
13. From the **File** menu, choose **Print Results**.
 - Select the printer to send the text results to.
 - Choose Ok.
14. From the **File** menu, choose **Print Screen**.
 - Select the printer to send the graphical results to.
 - Choose Ok.

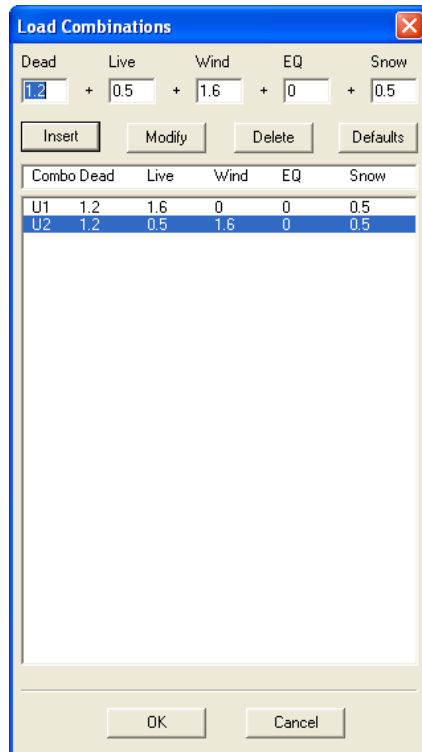

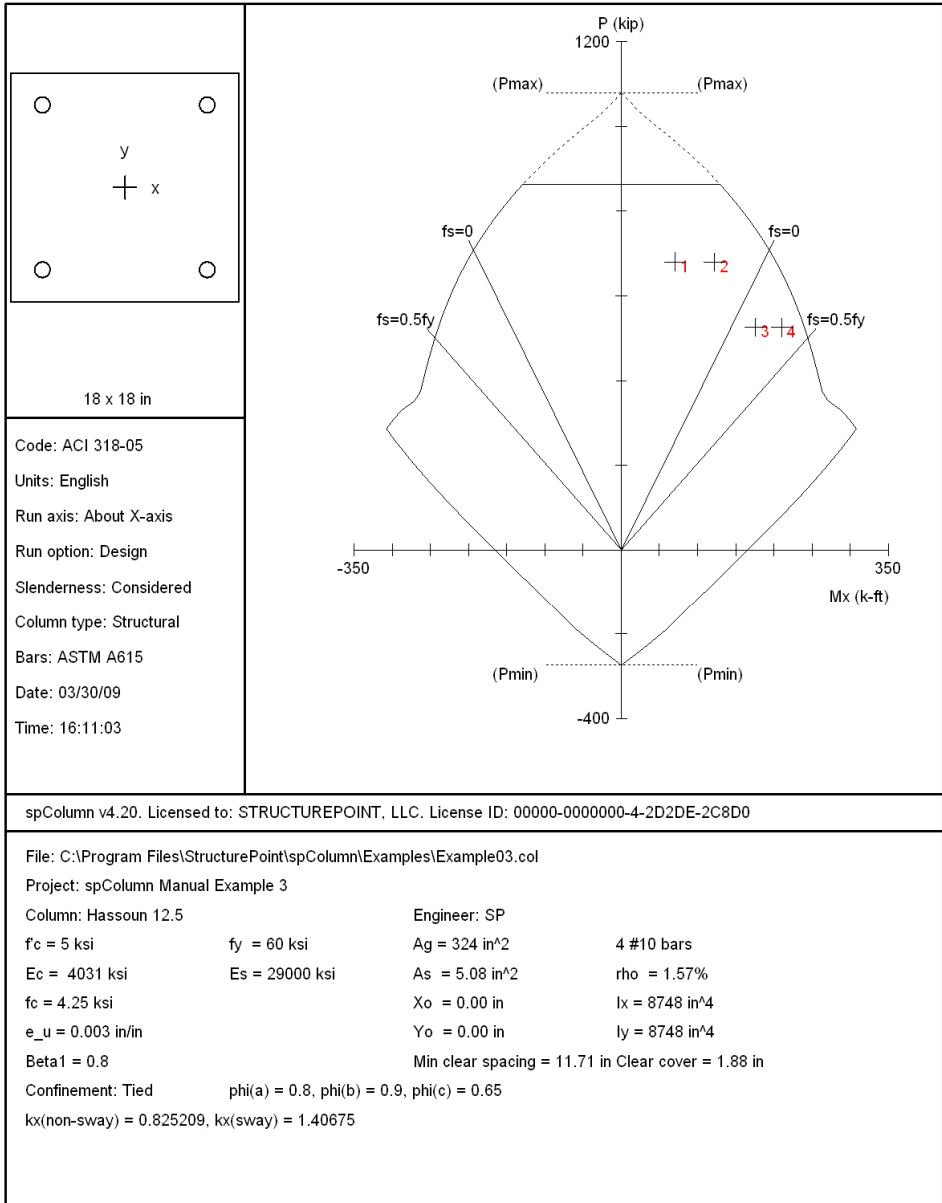

General Information:

```

=====
File Name: C:\Program Files\StructurePoint\spColumn\Examples\Example03.col
Project:  spColumn Manual Example 3
Column:   Hassoun 12.5
Code:     ACI 318-05
Engineer: SP
Units:    English

Run Option: Design
Run Axis:  X-axis
Slenderness: Considered
Column Type: Structural
  
```

Material Properties:

```

=====
f'c = 5 ksi
Ec = 4030.51 ksi
Ultimate strain = 0.003 in/in
Beta1 = 0.8
fy = 60 ksi
Es = 29000 ksi
  
```

Section:

```

=====
Rectangular: Width = 18 in
Depth = 18 in

Gross section area, Ag = 324 in^2
Ix = 8748 in^4
Iy = 8748 in^4
Xo = 0 in
Yo = 0 in
  
```

Reinforcement:

```

=====
Bar Set: ASTM A615
Size Diam (in) Area (in^2) Size Diam (in) Area (in^2) Size Diam (in) Area (in^2)
-----
# 3 0.38 0.11 # 4 0.50 0.20 # 5 0.63 0.31
# 6 0.75 0.44 # 7 0.88 0.60 # 8 1.00 0.79
# 9 1.13 1.00 # 10 1.27 1.27 # 11 1.41 1.56
# 14 1.69 2.25 # 18 2.26 4.00
  
```

Bar selection: Minimum number of bars
 $As_{min} = 0.01 * Ag = 3.24 \text{ in}^2$, $As_{max} = 0.08 * Ag = 25.92 \text{ in}^2$

Confinement: Tied; #3 ties with #10 bars, #4 with larger bars.
 $\phi(a) = 0.8$, $\phi(b) = 0.9$, $\phi(c) = 0.65$

Layout: Rectangular
 Pattern: All Sides Equal (Cover to transverse reinforcement)
 Total steel area: $As = 5.08 \text{ in}^2$ at $\rho = 1.57\%$
 4 #10 Cover = 1.5 in

Slenderness:

```

=====
Sway Criteria:
-----
X-axis: Non-sway column. Sum of Pc = 28.67*Pc Sum of Pu = 27.33*Pu
  
```

Column Axis	Height ft	Width in	Depth in	I in ⁴	f'c ksi	Ec ksi
Design X	16	18	18	8748	5	4030.51
Above X	11	18	18	8748	5	4030.51
Below X	11	18	18	8748	5	4030.51

X-Beams Location	Length ft	Width in	Depth in	I in ⁴	f'c ksi	Ec ksi
Above Left	20	0	0.0001	21436.6	5	4030.51
Above Right	20	0.0001	0.0001	21436.6	5	4030.51
Below Left	20	0.0001	0.0001	21436.6	5	4030.51
Below Right	20	0.0001	0.0001	21436.6	5	4030.51

Effective Length Factors:

Axis	Psi (top)	Psi (bot)	k (Non-sway)	k (Sway)	klu/r
X	1.252	1.252	0.825	1.407	51.98

Moment Magnification Factors:

Member resistance factor, $\phi(K) = 0.75$
 Cracked-section coefficients: $cI(\text{beams}) = 0.35$; $cI(\text{columns}) = 0.7$

$0.2 * E_c * I_g + E_s * I_{se} \text{ (X-axis)} = 1.33e+007 \text{ kip-in}^2$

X-axis Ld/Comb	Non-sway				Sway	
	Pc (kip)	Betad	Cm	Delta	Pc (kip)	Delta
1 U1	3120	0.671	0.830	1.170	1794	1.930
U2	2792	0.867	0.915	1.223	1794	1.594

Load Combinations:

U1 = 1.200*Dead + 1.600*Live + 0.000*Wind + 0.000*EarthQuake + 0.000*Snow
 U2 = 1.200*Dead + 0.500*Live + 1.600*Wind + 0.000*EarthQuake + 0.000*Snow

Service Loads:

Load No. Case	Axial Load kip	Mx @ Top k-ft	Mx @ Bot k-ft	My @ Top k-ft	My @ Bot k-ft
1 Dead	380.00	32.00	-54.00	0.00	0.00
Live	140.00	20.00	-36.00	0.00	0.00
Wind	0.00	50.00	-50.00	0.00	0.00
EQ	0.00	0.00	0.00	0.00	0.00
Snow	0.00	0.00	0.00	0.00	0.00

Factored Loads and Moments with Corresponding Capacities:

NOTE: Each loading combination includes the following cases:

First line - at column top		Second line - at column bottom		fMnx k-ft	fMn/Mu	N.A. depth in	eps _t	Phi
Load No. Combo	Pu kip	Mux k-ft	Muy k-ft					
1	1 U1	680.00	70.40	202.73	2.880	14.92	0.00011	0.650
2		680.00	122.40	202.73	1.656	14.92	0.00011	0.650
3	1 U2	526.00	175.94	239.75	1.363	11.97	0.00088	0.650
4		526.00	210.34	239.75	1.140	11.97	0.00088	0.650

*** End of output ***

Chapter 6

spSection Module

spSection is an add-on module to the spColumn program. It enables the user to investigate irregularly shaped reinforced concrete sections subject to a combination of loadings. spSection considers a polygonal section reinforced with bars located at any location. The section may contain one opening. In addition, spSection allows easy modification of a circular section by converting it into an approximate polygon.

spSection is accessed from within spColumn. Once spColumn is started, you can activate spSection by selecting the **Section | Irregular** command from the **Input** menu. This starts spSection, minimizes and locks the spColumn window and maximizes the spSection window. The section geometry may then be defined by drawing it on the screen or by inputting the coordinates of the polygon nodes. Once the section definition is complete, return to spColumn by selecting **Save and Exit** from the **Main** menu.

Once the irregular section is defined, its reinforcement is input using spSection as well. This is done by selecting the **Reinforcement | Irregular** command from the Input menu of spColumn. The section reinforcement may also be defined graphically.

Main Menu

Drawing Area

Set the limits for the drawing area and control the grid and snap settings.

Save and Exit

Accept the input and/or modifications made in spSection and return to spColumn.

Exit without Saving

Discard the input and/or modifications made in spSection and return to spColumn.

Edit Menu

Section

Toggles the input/editing session to the section.

Opening

Toggles the input/editing session to the section opening.

Reinforcement

Toggles the input/editing session to the section reinforcement.

Add

Switches to the Add mode to graphically insert section or opening nodes or reinforcing bars.

Delete

Switches to the Delete mode to graphically delete section or opening nodes or reinforcing bars.

Move

Switches to the Move mode to graphically move section or opening nodes or reinforcing bars.

Modify

Allows manual editing of the section or opening node coordinates or the reinforcing bar area and coordinates.

View Menu

Zoom

Magnifies or reduces the graphical image.

Pan

Translates or moves the graphical image.

Redraw

Redraws the displayed section and resets the Zoom and Pan actions.

Grid

Shows or hides the grid.

Snap

Toggles the Snap On and Off. With the SNAP ON, the cursor snaps (sticks) to exact locations.

Labels

Shows or hides the internal numbering of section (or opening) nodes and bars.

Status bar

Shows or hides the Status bar.

Help Menu

spSection Help

Lists all the available help topics about the program.

spColumn Manual

Opens spColumn Manual in the default PDF viewer.

About

Displays copyright information and the version number of the program.

Defining the Drawing Area

- Select **Main | Drawing Area**. A dialog box appears. This step is not needed the first time spSection is started using spColumn's **Section | Irregular** command. The box is automatically displayed.
- Input the limits (MINIMUM and MAXIMUM) of the area within which the section is to be drawn in both directions.
- Input the interval (step) for the grid system. The grid is used as a guideline when drawing.
- Select or clear the SHOW GRID option to show or hide the grid.
- Input the interval (STEP) for the snap. The snap settings may be different than the grid settings and may be different in each direction (x and y).
- Select or clear the SNAP ON option to activate or disable the Snap.
- Choose the OK button.

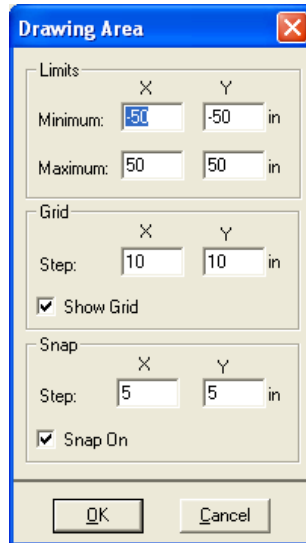

Graphical Editing of the Section or Opening

In spSection, the section (or opening) must be a closed polygon. It is defined by inputting the nodes at each corner or vertex of the polygon. No two segments (sides) may overlap or cross and no two nodes may coincide. An opening must lie completely within the section.

The coordinates that correspond to the cursor location are always displayed in the Status bar. To force the cursor to “stick” to exact locations, turn the SNAP option on. The program will snap to locations whose coordinates are multiples of the snap steps.

To add section or opening nodes:

- Switch the input session to Section (or Opening) by selecting **Edit | Section** (or **Edit | Opening**).
- Switch the input mode to ADD by selecting **Edit | Add**.
- If you are editing a section (or opening), you must first click on an existing node. Once this is done, you can insert subsequent nodes.
- Adding a node is done by moving the cursor to a desired location within the Graphics area and clicking the left-mouse button.
- After inserting a node, a line extending from the last added node follows the cursor. Click at another location to insert subsequent nodes. A line connecting the two nodes is drawn.
- To end the drawing, click the right-mouse button or press the ESC key. The first and last nodes are connected to close the section. Also note that while in the ADD mode, moving the cursor outside the Graphics area ends the drawing.

To delete section or opening nodes:

- Switch the input session to Section (or Opening) by selecting **Edit | Section** (or **Edit | Opening**).
- Switch the input mode to DELETE by selecting **Edit | Delete**.
- Marquee select the node (or nodes) to be deleted. This is done by moving the cursor to one location, pressing the left-mouse button and while holding the button down, moving to another location. While moving, a dotted rectangle (called the marquee) is drawn. Releasing the left-mouse button ends the marquee. All nodes that are enclosed with the marquee are deleted and the section (or opening) is redrawn. To cancel a marquee action while holding down the left-mouse button, press the ESC key or click the right-mouse button. Also, leaving the Graphics area cancels the marquee operation.

To move section or opening nodes:

- Switch the input session to Section (or Opening) by selecting **Edit | Section** (or **Edit | Opening**).
- Switch the input mode to Move by selecting **Edit | Move**.

- Place the cursor over the node to be moved then press and hold the left-mouse button. As long as the button is held down, moving the cursor moves the selected node to the cursor location. Once the node is at the new desired location, release the mouse button. To cancel a move action while holding down the left-mouse button, press the ESC key or click the right-mouse button. Also, leaving the Graphics area cancels the move operation.

Graphical Editing of the Reinforcement

In spSection, the reinforcing bars may be located anywhere. The only restriction imposed in the program is that no two bars may overlap. The coordinates that correspond to the cursor location are always displayed in the Status bar. To force the cursor to “stick” to exact locations, turn the Snap option on. The program will snap to locations whose coordinates are multiples of the snap steps. While in the Reinforcement session, you cannot switch to the Section or Opening sessions without returning to spColumn. Therefore, the Edit | Reinforcement command will have a check mark to its left. You use the command to specify the bar size or area and the number of bars to be added.

To add one single bar at a time:

- Switch the input mode to Add by selecting **Edit | Add**.
- Select **Reinforcement** from the **Edit** menu. A dialog box appears.
- In the Number of bars box, input 1.
- Choose the Size option and select the size of the bar or choose the Area option and input the bar area in the edit box.
- Choose the OK button.
- In the Graphics area, point to the desired location and click. A bar is inserted.
- Repeat the step above to insert more bars.

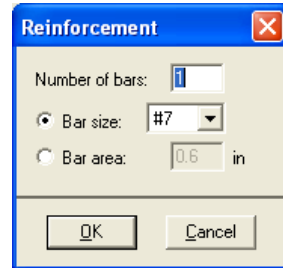

To generate multiple bars:

- Switch the input mode to Add by selecting **Edit | Add**. The command must have a check mark left of it.

- Select **Reinforcement** from the **Edit** menu. A dialog box appears.
- Input the number of bars to be generated (should be greater than 1).
- Choose the Size option and select the size of the bar or choose the Area option and input the bar area in the edit box.
- Choose the OK button.
- In the Graphics area, click at a location (let us call it point A), move the cursor to another location and click (let us call it Point B). The specified number of equally-spaced bars is added, along the line connecting the points A and B. For subsequent generations, point B becomes A and you only need to click at the second point (B) to generate more bars.
- To end the multiple bar generation or move to another location (without adding bars), click the right-mouse button or press the ESC key. Also note that while in the multiple bar generation of the Add mode, moving the cursor outside the Graphics area aborts the generation.

To delete bars:

- Switch the input mode to DELETE by selecting **Edit | Delete**.
- Marquee select the bar(s) to be deleted. This is done by moving the cursor to one location, pressing the left-mouse button and while holding the button down, moving to another location. While moving, a dotted rectangle (called the marquee) is drawn. Releasing the left-mouse button end the marquee. All bars that are enclosed with the marquee are deleted. To cancel a marquee action while holding down the left-mouse button, press the ESC key or click the right-mouse button. Also, leaving the Graphics area cancels the marquee operation.

To move a bar:

- Switch the input mode to Move by selecting **Edit | Move**.
- Place the cursor over the bar to be moved then press and hold the left-mouse button. As long as the button is held down, moving the cursor moves the selected bar with it. Once the bar is at the new desired location, release the mouse button. To cancel a move action while holding down the left-mouse button, press the ESC key or click the right-mouse button. Also, leaving the Graphics area cancels the move operation.

Manual Editing of the Section or Opening

- Switch the input session to Section (or Opening) by selecting **Edit | Section** (or **Edit | Opening**).
- Select **Edit | Modify**. A dialog box appears. If you have already defined a section (or opening), the coordinates of its nodes are shown in the list.
- To add a node, enter its x and y coordinates and choose the INSERT button. The entry is inserted in the list box following the selected entry.
- To edit an entry, select it from the list box, modify its values in the text boxes, and choose the MODIFY button.
- To delete an entry, choose it from the list box and choose the DELETE button.
- Choose the OK button.

No.	X	Y
1	-10	25
2	0	30
3	5	20
4	5	5
5	-5	0
6	-5	15

Manual Editing of the Reinforcement

- Select **Edit | Modify**. A dialog box appears.
- To edit an entry, select it from the list box, modify its values in the text boxes, and choose the MODIFY button. You can change the area of a group of bars by selecting them from the list, enter the new area and choose MODIFY.
- To delete an entry, choose it from the list box and choose the DELETE button.
- Choose the OK button.

No.	Area	X	Y
3	0.6	10	10
4	0.6	10	20
5	0.6	0	20
6	0.6	-10	20
7	0.6	-10	30
8	0.6	0	30
9	0.6	10	30
10	0.6	-45	45

Zooming and Panning the Image

Zooming is the enlargement or reduction of the graphical image. Panning is the translation or movement of the image.

Zooming:

- Select **View | Zoom**.
- To enlarge the view (zoom-in): using the left-mouse button, click anywhere within the Graphics area. Click again for further magnification.
- To reduce the view (zoom-out): using the right-mouse button, click anywhere within the Graphics area. Click again for further reduction.
- To reset the Zoom and return to the default, select **View | Redraw**.

Panning:

- Select **View | Pan**.
- Place the cursor over the Graphics area. Press the left-mouse button and, while still holding the button, move the cursor in the direction you wish to pan. A line showing the amount and direction of panning is drawn.
- Release the mouse button. The view is panned and the image is redrawn.
- To reset the Pan and return to the default, select **View | Redraw**.

Keyboard shortcuts:

The following keyboard assignments are always active:

<u>Key combination</u>	<u>Action</u>
Ctrl + Page Up	Zoom-in
Ctrl + Page Down	Zoom-out
Ctrl + Cursor key	Pan
Enter	Reset zoom/pan (Redraw)

Example 4 – Capacity of an Irregular Section

Compute horizontal moment capacity M_x of the unsymmetrical beam cross section⁶³ shown below. Use 3-ksi concrete and 60-ksi reinforcing steel.

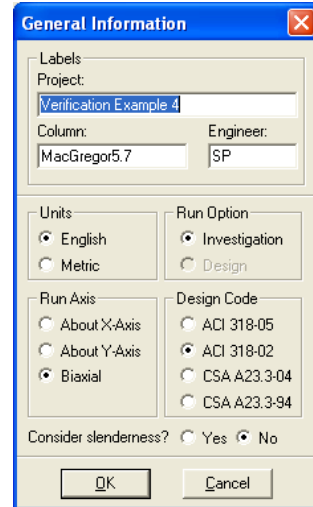
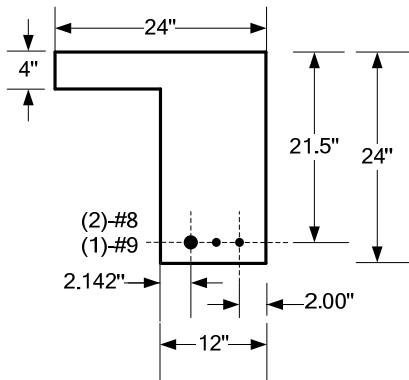

Note: when instructed to move to a location (15, 25), move the cursor until the cells in the Status bar show “x=15” and “y=25”.

From the **File** menu, choose **New**. Any input data is cleared and the default values are restored.

- From the **Input** menu, choose **General Information**.
 - Select **ENGLISH UNITS** and **ACI 318-02** code.
 - Select **BIAXIAL** for **RUN AXIS**, **Investigation** for run option and **NO** for **CONSIDER SLENDERNESS?**
 - Choose **OK**.

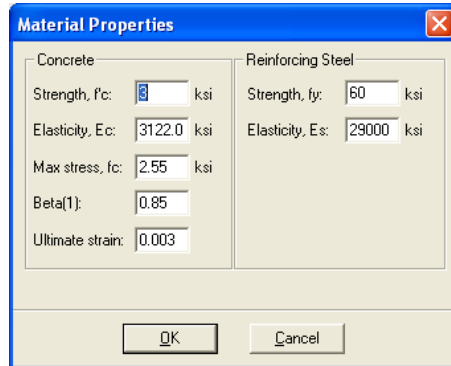

⁶³ Based on Example 5.7, pp 199 from Reinforced Concrete: Mechanics and Design, Fourth Edition, 2005, Pearson Prentice Hall, Pearson Education Inc.

2. From the **Input** menu, choose **Material Properties**.
 - Under CONCRETE, input 3 for the STRENGTH. Other properties are computed and will be accepted.
 - Choose OK.
3. From the **Input** menu, choose **Section | Irregular**. The spSection module is loaded, its window occupies the desktop, and the DRAWING AREA box appears.
 - Under Limits, input 0 and 20 for the MINIMUM X and MINIMUM Y, respectively.
 - Under limits, input 24 and 4 for the MAXIMUM X and MAXIMUM Y, respectively.
 - Under GRID, input 4 and 4 for X and Y grid STEP, respectively and check the SHOW GRID option.
 - Under SNAP, input 4 and 4 for X and Y STEP, respectively and check the SNAP ON option.
 - Choose OK.
4. The default input session is Section and the default input mode is Add (the **Edit | Section** and **Edit | Add** options are checked).
 - In the Graphics area, move the cursor to the location (0, 0) and click the left mouse button. A node is inserted.
 - Move to (12, 0) and click the left mouse button.
 - Move to (12, -20) and click the left mouse button.
 - Move to (24, -20) and click the left mouse button.
 - Move to (24, 4) and click the left mouse button.
 - Move to (0, 4) and click the left mouse button.
 - Move to (0, 0) and click the left mouse button.
 - Click the right-mouse button to end drawing the section.
5. From the **Main** menu, choose **Save and Exit**. You are returned to spColumn and the section is shown in the Information bar.

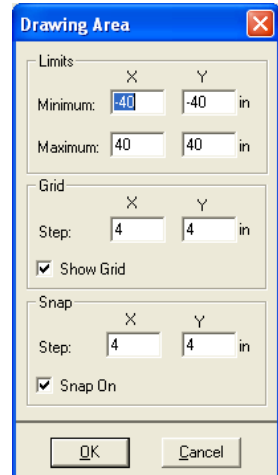

6. From the **Input** menu, choose **Reinforcement | Irregular**. The spSection module is loaded, its window occupies the desktop.
7. The default input session is Reinforcement and the default input mode is Add (the **Edit | Reinforcement** and **Edit | Add** options are checked).
8. Define some bars using multiple bar generation:

- From the **Edit** menu, choose **Reinforcement**. Input 1 for the NUMBER OF BARS and select #9 for the BAR SIZE. Choose OK.

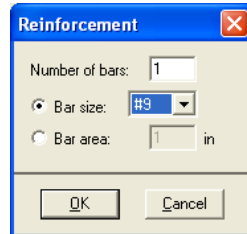

- Move the cursor to any location and click the left mouse button.

- From the **Edit** menu, choose **Modify**. Input 14.142 for X-COORD and -17.5 for Y-COORD. Click MODIFY and then OK.

- From the **Edit** menu, choose **Reinforcement**. Input 1 for the NUMBER OF BARS and select #8 from BAR SIZE. Choose OK.

- Move the cursor to any location and click the left mouse button. A #8 bar is generated at that location.

- From the **Edit** menu choose **Modify**. Input 18 for X-COORD and -17.5 for Y-COORD. Click MODIFY and then OK.

- From the **Edit** menu, choose **Reinforcement**. Input 1 for the NUMBER OF BARS and select #8 from BAR SIZE. Choose OK.

- Move the cursor to any location and click the left mouse button. A #8 bar is generated at that location.

- From the **Edit** menu choose **Modify**. Input 22 for X-COORD and -17.5 for Y-COORD. Click Modify and then Ok

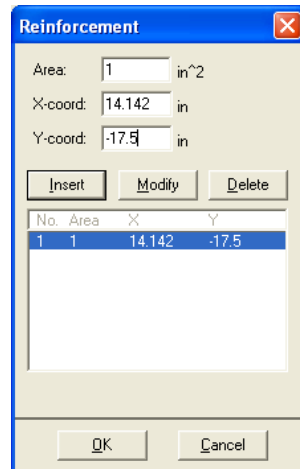

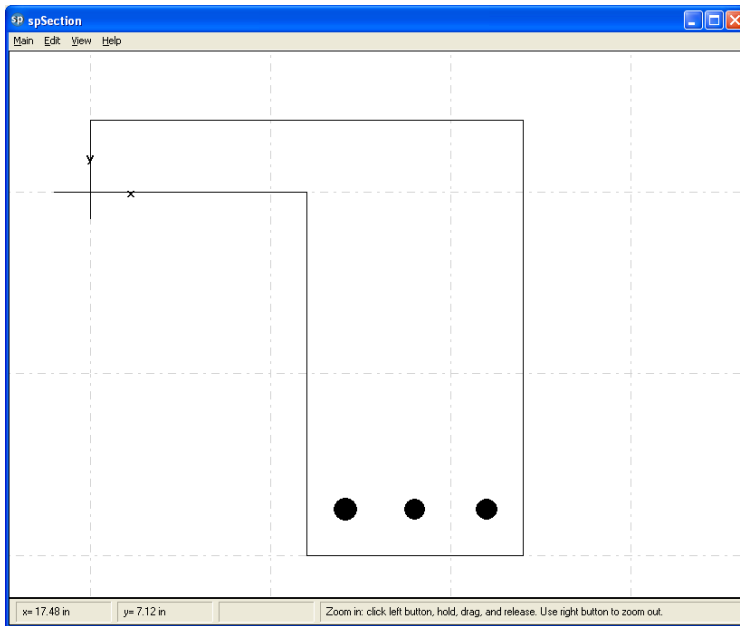

9. From the **Main** menu, choose **Save and Exit**. You are returned to spColumn and the section is shown in the Information bar.
10. From the **Input** menu, choose **Input | Loads | .Factored**
11. Enter LOAD as 0 (zero), X-MOMENT as -225 ft-kips and Y-MOMENT as 0.
12. From the **Solve** menu, choose **Execute**.
 - A message is displayed saying “Reinforcement ratio is less than 1% Consider column as architectural (i.e. f_c is reduced by reinforcement ratio?)”. Click No for this option.
 - The solver of the program is started and, upon completion, displays the interaction diagram of the section.
13. From the **View** menu, choose **Results**.

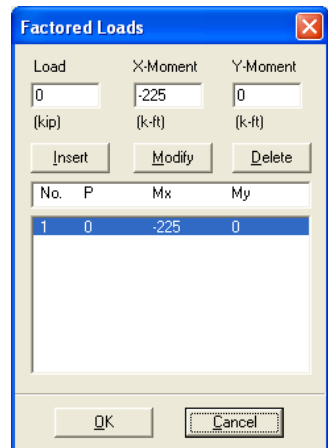

- Page through the results file.
 - Choose **Exit** to quit the spView program and get back to spColumn.
14. From the **File** menu, choose **Print Results**.
- Select the printer to send the text results to.
 - Choose OK.
15. From the **File** menu, choose **Print Screen**.
- Select the printer to send the graphical results to.
 - Choose OK
 - Change the interaction diagram to show the P-M diagram at 180° using the  icon.

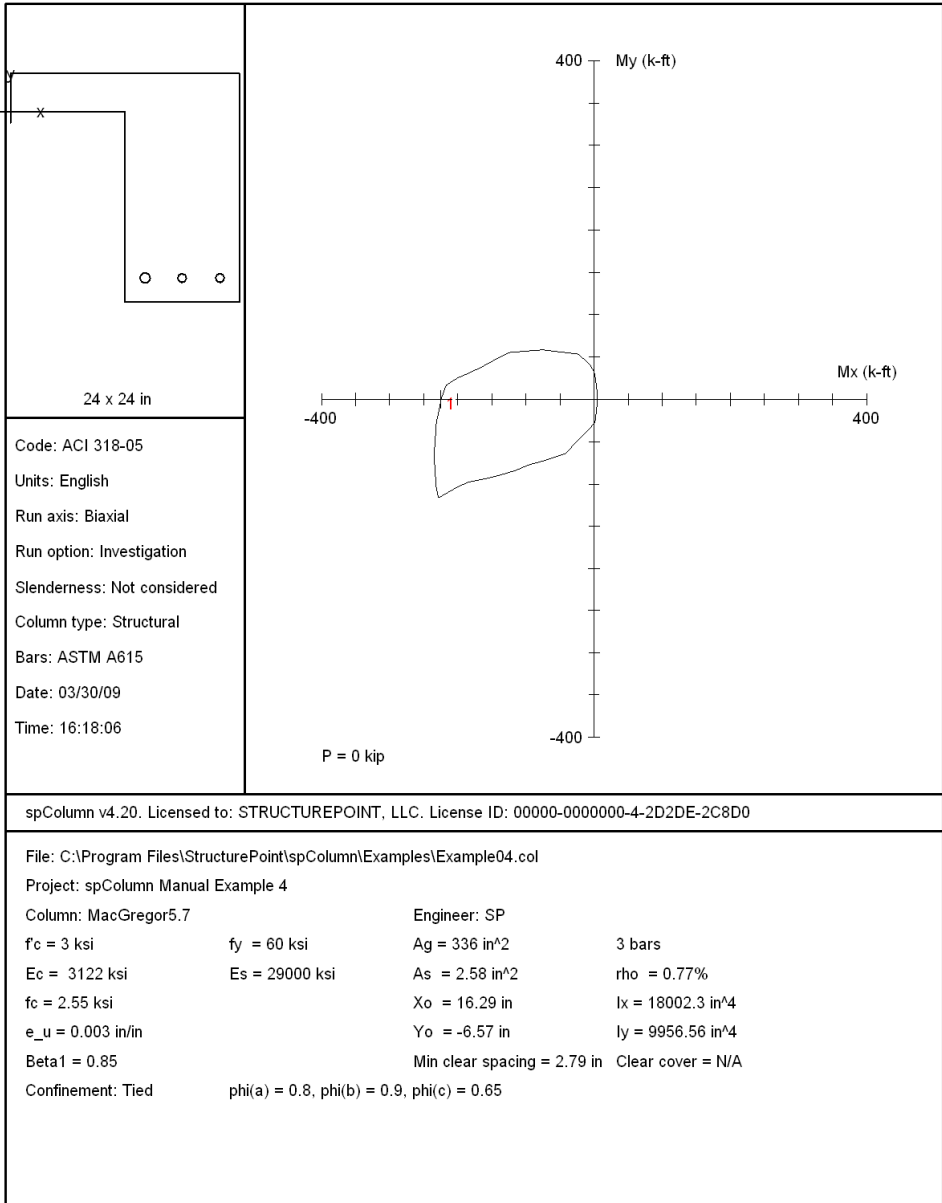

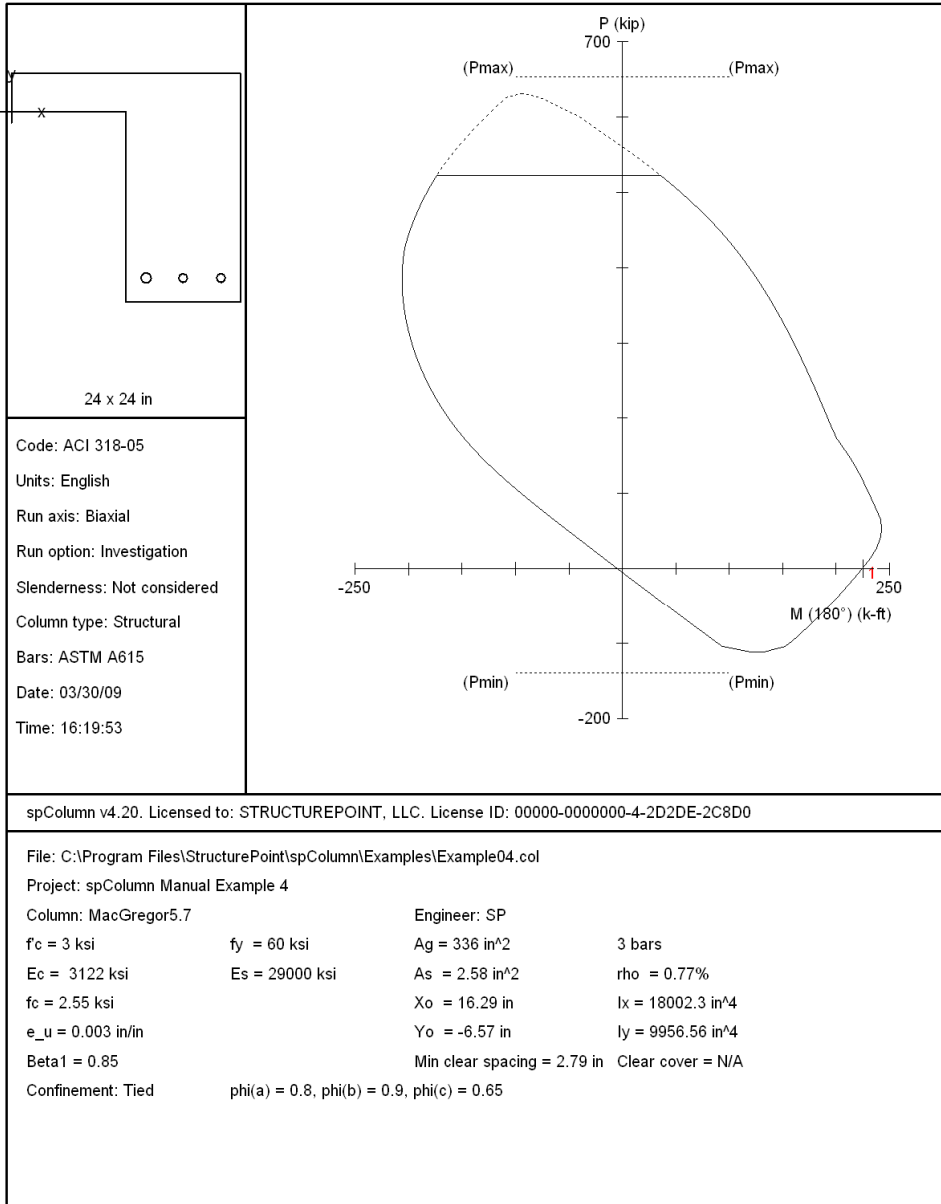

STRUCTUREPOINT - spColumn v4.20 (TM)
 Licensed to: STRUCTUREPOINT, LLC. License ID: 00000-0000000-4-2D2DE-2C8D0
 C:\Program Files\StructurePoint\spColumn\Examples\Example04.col

Page 2
 03/30/09
 04:17 PM

General Information:

```

=====
File Name: C:\Program Files\StructurePoint\spColumn\Examples\Example04.col
Project:  spColumn Manual Example 4
Column:   MacGregor5.7
Code:     ACI 318-05
Engineer: SP
Units:    English

Run Option: Investigation
Run Axis:  Biaxial
Slenderness: Not considered
Column Type: Structural
  
```

Material Properties:

```

=====
f'c = 3 ksi          fy = 60 ksi
Ec = 3122.02 ksi    Es = 29000 ksi
Ultimate strain = 0.003 in/in
Beta1 = 0.85
  
```

Section:

```

=====
Exterior Points
No.   X (in)   Y (in)   No.   X (in)   Y (in)   No.   X (in)   Y (in)
-----
1      0.0      0.0      2      12.0     0.0      3      12.0     -20.0
4      24.0     -20.0    5      24.0     4.0      6      0.0      4.0

Gross section area, Ag = 336 in^2
Ix = 18002.3 in^4      Iy = 9956.56 in^4
Xo = 16.2857 in       Yo = -6.57143 in
  
```

Reinforcement:

```

=====
Bar Set: ASTM A615
Size Diam (in) Area (in^2)   Size Diam (in) Area (in^2)   Size Diam (in) Area (in^2)
-----
# 3    0.38    0.11   # 4    0.50    0.20   # 5    0.63    0.31
# 6    0.75    0.44   # 7    0.88    0.60   # 8    1.00    0.79
# 9    1.13    1.00   # 10   1.27    1.27   # 11   1.41    1.56
# 14   1.69    2.25   # 18   2.26    4.00
  
```

Confinement: Tied; #3 ties with #10 bars, #4 with larger bars.
 phi(a) = 0.8, phi(b) = 0.9, phi(c) = 0.65

Pattern: Irregular

Total steel area, As = 2.58 in^2 at 0.77% (Note: rho < 1.0%)

```

Area in^2   X (in)   Y (in)   Area in^2   X (in)   Y (in)   Area in^2   X (in)   Y (in)
-----
1.00      14.1    -17.5    0.79      18.0    -17.5    0.79      22.0    -17.5
  
```

Factored Loads and Moments with Corresponding Capacities:

```

=====
No.      Pu      Mux      Muy      fMnx      fMny      fMn/Mu      Phi
-----
1        0.00    -225.00    0.00    -224.43    -0.00    0.997    0.900#
  
```

Section capacity exceeded!

*** End of output ***

Appendix

Import File Formats

Geometry, reinforcement or load data may be imported from a text file. The import file must be saved in pure ASCII (text) format. Data fields on each line should be separated by spaces or TABs. Comments or blank lines should not be placed within the import file.

Service Loads Data:

```
No Of Load Points
P1_D M1x_DT M1x_DB M1y_DB M1y_DB
P1_L M1x_LT M1x_LB M1y_LT M1y_LB
P1_W M1x_WT M1x_WB M1y_WT M1y_WB
P1_EQ M1x_EQT M1x_EQB M1y_EQT M1y_EQB
P1_S M1x_ST M1x_SB M1y_ST M1y_SB
.
.
Pn_D Mnx_DT Mnx_DB Mny_DB Mny_DB
Pn_L Mnx_LT Mnx_LB Mny_LT Mny_LB
Pn_W Mnx_WT Mnx_WB Mny_WT Mny_WB
Pn_EQ Mnx_EQT Mnx_EQB Mny_EQT Mny_EQB
Pn_S Mnx_ST Mnx_SB Mny_ST Mny_SB
```

Each service load point has five lines of data (one line for each load case, i.e. Dead, Live, Wind, Earthquake, and Snow). Each data line has five values. For a service load point i , P_{i_D} , M_{ix_DT} , M_{ix_DB} , M_{iy_DT} , and M_{iy_DB} are the axial load, M_x at top, M_x at bottom, M_y at top and M_y at bottom, respectively. The notation D, L, W, EQ, and S designate the Dead, Live, Wind, Earthquake, and Snow load cases, respectively.

Factored Loads Data:

```
No Of Load Points
P1 M1x M1y
P2 M2x M2y
.
.
Pn Mnx Mny
```

For a factored load point i , P_i is the factored axial load, M_{ix} is the factored moment about x and M_{iy} is the factored moment about y .

Reinforcement Data:

```
No_Of_Bars
A1 X1 Y1
.
.
An Xn Yn
```

For a bar i , A_i is the bar area, X_i is its x -coordinate, and Y_i is its y -coordinate.

Geometry Data:

```
No_Of_Section_Nodes
Xs1 Ys1
Xs2 Ys2
.
.
.
Xsn Ysn
No_Of_Opening_Nodes
Xo1 Yo1
Xo2 Yo2
.
.
.
Xon Yon
```

For a section node s_i , X_{s_i} is the x -coordinate of the node and Y_{s_i} is its y -coordinate.

For an opening node o_i , X_{o_i} is the x -coordinate of the node and Y_{o_i} is its y -coordinate.

If the section does not contain an opening, you must have a zero for the value of `No_Of_Opening_Nodes`.

spColumn Text Input (CTI) file format

spColumn is able to read and save input data file into two formats, COL file or CTI file. CTI files are plain text files that can be edited by any text editing software.

Caution must be used when editing a CTI file because some values may be interrelated. If one of these values is changed, then other interrelated values should be changed accordingly. While this is done automatically when a model is edited in the spColumn user graphic user interface (GUI), one must update all the related values in a CTI file manually in order to obtain correct results. For example, if units are changed from English to Metric in GUI, all the related input values are updated automatically. If this is done by editing a CTI file, however, not only the unit flag but also all the related input values must be updated manually.

The best way to create a CTI file is by using the spColumn GUI and selecting CTI file type in the Save As menu command. Then, any necessary modifications to the CTI file can be applied with any text editor. However, it is recommended that users always verify modified CTI files by loading them in the spColumn GUI to ensure that the modifications are correct before running manually revised CTI files in batch mode.

A CTI file is organized by sections. Each section contains a title in square brackets, followed by values required by the section. A CTI file contains the following sections.

```
[spColumn Version]
[Project]
[Column ID]
[Engineer]
[Investigation Run Flag]
[Design Run Flag]
[Slenderness Flag]
[User Options]
[Irregular Options]
[Ties]
[Investigation Reinforcement]
[Design Reinforcement]
[Investigation Section Dimensions]
```

```
[Design Section Dimensions]
[Material Properties]
[Reduction Factors]
[Design Criteria]
[External Points]
[Internal Points]
[Reinforcement Bars]
[Factored Loads]
[Slenderness: Column]
[Slenderness: Column Above And Below]
[Slenderness: Beams]
[EI]
[SldOptFact]
[Phi_Delta]
[Cracked I]
[Service Loads]
[Load Combinations]
[BarGroupType]
[User Defined Bars]
```

Each section of a CTI file and allowable values of each parameter are described in details below. Corresponding GUI commands are presented in parenthesis.

#spColumn Text Input (CTI) File

A number sign, #, at the beginning of a line of text indicates that the line of text is comment. The # sign must be located at the beginning of a line. Comments may be added anywhere necessary in a CTI file to make the file more readable. If a comment appears in multiple lines, each line must be started with a # sign.

```
[spColumn Version]
Reserved. Do not edit.
```

```
[Project]
There is one line of text in this section.
```

Project name (menu Input | General Information...)

```
[Column ID]
There is one line of text in this section.
```

Column ID (menu Input | General Information...)

[Engineer]

There is one line of text in this section.

Engineer name (Menu Input | General Information...)

[Investigation Run Flag]

Reserved. Do not edit.

[Design Run Flag]

Reserved. Do not edit.

[Slenderness Flag]

Reserved. Do not edit.

[User Options]

There are 26 values separated by commas in one line in this section. These values are described below in the order they appear from left to right.

1. 0-Investigation Mode; 1-Design Mode; (Run Option on menu Input | General Information...)
2. 0-English Unit; 1-Metric Units; (Units on menu Input | General Information...)
3. 0-ACI 318-02; 1- CSA A23.3-94; 2-ACI 318-05; 3-CSA A23.3-04; (Design Code on menu Input | General Information...)
4. 0-X Axis Run; 1-Y Axis Run; 2-Biaxial Run; (Run Axis on menu Input | General Information...)
5. Reserved. Do not edit.
6. 0-Slenderness is not considered; 1-Slenderness in considered; (Consider slenderness? on menu Input | General Information...)
7. 0-Design for minimum number of bars; 1-Design for minimum area of reinforcement; (Bar selection on menu Input | Reinforcement | Design Criteria...)
8. Reserved. Do not edit.
9. 0-Rectangular Column Section; 1-Circular Column Section; 2-Irregular Column Section; (menu Input | Section)
10. 0-Rectangular reinforcing bar layout; 1-Circular reinforcing bar layout; (Bar Layout on menu Input | Reinforcement | All Sides Equal)

11. 0-Structural Column Section; 1-Architectural Column Section; 2-User Defined Column Section; (Column Type on menu Input | Reinforcement | Design Criteria...)
12. 0-Tied Confinement; 1-Spiral Confinement; 2-Other Confinement; (Confinement drop-down list on menu Input | Reinforcement | Confinement...)
13. Load type for investigation mode: (menu Input | Loads)
0-Factored; 1-Service; 2-Control Points; 3-Axial Loads
14. Load type for design mode: (menu Input | Loads)
0-Factored; 1-Service; 2-Control Points; 3-Axial Loads
15. Reinforcement layout for investigation mode: (menu Input | Reinforcement)
0-All Side Equal; 1-Equal Spacing; 2-Sides Different; 3-Irregular Pattern
16. Reinforcement layout for design mode: (menu Input | Reinforcement)
0-All Side Equal; 1-Equal Spacing; 2-Sides Different; 3-Irregular Pattern
17. Reserved. Do not edit.
18. Number of factored loads (menu Input | Loads | Factored...)
19. Number of service loads (menu Input | Loads | Service...)
20. Number of points on exterior column section
21. Number of points on interior section opening
22. Reserved. Do not edit.
23. Reserved. Do not edit.
24. Cover type for investigation mode: (menu Input | Reinforcement)
0-To transverse bar; 1-To longitudinal bar
25. Cover type for design mode: (menu Input | Reinforcement)
0-To transverse bar; 1-To longitudinal bar
26. Number of load combinations; (menu Input | Load | Load Combinations...)

[Irregular Options]

There are 13 values separated by commas in one line in this section. These values are described below in the order they appear from left to right. (menu Input | Section | Irregular | Section Editor menu Main | Drawing Area)

1. Reserved. Do not edit.
2. Reserved. Do not edit.
3. Reserved. Do not edit.
4. Reserved. Do not edit.
5. Area of reinforcing bar that is to be added through irregular section editor
6. Maximum X value of drawing area of irregular section editor
7. Maximum Y value of drawing area of irregular section editor
8. Minimum X value of drawing area of irregular section editor

9. Minimum Y value of drawing area of irregular section editor
10. Grid step in X of irregular section editor
11. Grid step in Y of irregular section editor
12. Grid snap step in X of irregular section editor
13. Grid snap step in Y of irregular section editor

[Ties]

There are 3 values separated by commas in one line in this section. These values are described below in the order they appear from left to right. (Menu Input | Reinforcement | Confinement...)

1. Index (0 based) of tie bars for longitudinal bars smaller than the one specified in the 3rd item in this section in the drop-down list
2. Index (0 based) of tie bars for longitudinal bars bigger than the one specified in the 3rd item in this section in the drop-down list
3. Index (0 based) of longitudinal bar in the drop-down list

[Investigation Reinforcement]

This section applies to investigation mode only. There are 12 values separated by commas in one line in this section. These values are described below in the order they appear from left to right.

If Side Different (Menu Input | Reinforcement | Side Different...) is selected:

1. Number of top bars
2. Number of bottom bars
3. Number of left bars
4. Number of right bars
5. Index (0 based) of top bars (Top Bar Size drop-down list)
6. Index (0 based) of bottom bars (Bottom Bar Size drop-down list)
7. Index (0 based) of left bars (Left Bar Size drop-down list)
8. Index (0 based) of right bars (Right Bar Size drop-down list)
9. Clear cover to top bars
10. Clear cover to bottom bars
11. Clear cover to left bars
12. Clear cover to right bars

If All Sides Equal (Menu Input | Reinforcement | All Sides Equal...) or Equal Spacing (Menu Input | Reinforcement | Equal Spacing...) is selected:

1. Number of bars (No. of Bars text box)
2. Reserved. Do not edit.
3. Reserved. Do not edit.
4. Reserved. Do not edit.
5. Index (0 based) of bar (Bar Size drop-down list)
6. Reserved. Do not edit.
7. Reserved. Do not edit.
8. Reserved. Do not edit.
9. Clear cover to bar (Clear Cover text box)
10. Reserved. Do not edit.
11. Reserved. Do not edit.
12. Reserved. Do not edit.

If Irregular Pattern (Menu Input | Reinforcement | Irregular Pattern...) is selected:

Reserved. Do not edit.

[Design Reinforcement]

This section applies to design mode only. There are 12 values separated by commas in one line in this section. These values are described below in the order they appear from left to right.

If Side Different (Menu Input | Reinforcement | Side Different...) is selected:

1. Minimum number of top and bottom bars
2. Maximum number of top and bottom bars
3. Minimum number of left and right bars
4. Maximum number of left and right bars
5. Index (0 based) of minimum size for top and bottom bars
6. Index (0 based) of maximum size for top and bottom bars
7. Index (0 based) of minimum size for left and right bars
8. Index (0 based) of maximum size for left and right bars
9. Clear cover to top and bottom bars
10. Reserved. Do not edit.
11. Clear cover to left and right bars
12. Reserved. Do not edit.

If All Sides Equal (Menu Input | Reinforcement | All Sides Equal...) or Equal Spacing (Menu Input | Reinforcement | Equal Spacing...) is selected:

1. Minimum number of bars
2. maximum number of bars
3. Reserved. Do not edit.
4. Reserved. Do not edit.
5. Index (0 based) of minimum size of bars
6. Index (0 based) of maximum size of bars
7. Reserved. Do not edit.
8. Reserved. Do not edit.
9. Clear cover
10. Reserved. Do not edit.
11. Reserved. Do not edit.
12. Reserved. Do not edit.

[Investigation Section Dimensions]

This section applies to investigation mode only. There are 2 values separated by commas in one line in this section. These values are described below in the order they appear from left to right.

If rectangular section (Menu Input | Section | Rectangular...) is selected:

1. Section width (along X)
2. Section depth (along Y)

If circular section (Menu Input | Section | Circular...) is selected:

1. Section diameter
2. Reserved. Do not edit.

If irregular section (Menu Input | Section | Irregular) is selected:

1. Reserved. Do not edit.
2. Reserved. Do not edit.

[Design Section Dimensions]

This section applies to design mode only. There are 6 values separated by commas in one line in this section. These values are described below in the order they appear from left to right.

If rectangular section (Menu Input | Section | Rectangular...) is selected:

1. Section width (along X) Start
2. Section depth (along Y) Start
3. Section width (along X) End
4. Section depth (along Y) End
5. Section width (along X) Increment
6. Section depth (along Y) Increment

If circular section (Menu Input | Section | Circular...) is selected:

1. Diameter start
2. Reserved. Do not change.
3. Diameter end
4. Reserved. Do not change.
5. Diameter increment
6. Reserved. Do not change.

[Material Properties]

There are 8 values separated by commas in one line in this section. These values are described below in the order they appear from left to right. (Menu Input | Material Properties...)

1. Concrete strength, f'_c
2. Concrete modulus of elasticity, E_c
3. Concrete maximum stress, f_c
4. Beta(1) for concrete stress block
5. Concrete ultimate strain
6. Steel yield strength, f_y
7. Steel modulus of elasticity, E_s
8. Reserved. Do not edit.

[Reduction Factors]

There are 4 values separated by commas in one line in this section. These values are described below in the order they appear from left to right. (Menu Input | Reinforcement | Confinement...)

1. Phi(a) for axial compression
2. Phi(b) for tension-controlled failure
3. Phi(c) for compression-controlled failure
4. Reserved. Do not edit.

[Design Criteria]

There are 4 values separated by commas in one line in this section. These values are described below in the order they appear from left to right. (Menu Input | Reinforcement | Design Criteria...)

1. Minimum reinforcement ratio
2. Maximum reinforcement ratio
3. Minimum clear spacing between bars
4. Design/Required ratio

[External Points]

This section applies to irregular section in investigation mode only. The first line contains the number of points on exterior section perimeter. Each of the following lines contains 2 values of X and Y coordinates (separated by comma) of a point.

```
Number of Points, n
Point_1_X, Point_1_Y
Point_2_X, Point_2_Y
.
.
.
Point_n_X, Point_n_Y
```

[Internal Points]

This section applies to irregular section in investigation mode only. The first line contains the number of points on an interior opening perimeter. Each of the following lines contains 2 values of X and Y coordinates (separated by comma) of a point. If no opening exists, then the first line must be 0.

```
Number of Points, n
Point_1_X, Point_1_Y
Point_2_X, Point_2_Y
.
.
.
Point_n_X, Point_n_Y
```

[Reinforcement Bars]

This section applies to irregular section in investigation mode only. The first line contains the number of reinforcing bars. Each of the following lines contains 3 values of area, X and Y coordinates (separated by comma) of a bar.

```
Number of bars, n
Bar_1_area, Bar_1_X, Bar_1_Y
Bar_2_area, Bar_2_X, Bar_2_Y
.
.
.
Bar_n_area, Bar_n_X, Bar_n_Y
```

[Factored Loads]

The first line contains the number of factored loads defined. Each of the following lines contains 3 values of axial load, X-moment, and Y-moment separated by commas. (Menu Input | Loads | Factored Loads...)

```
Number of Factored Loads, n
Load_1, X-Moment_1, Y-Moment_1
Load_2, X-Moment_2, Y-Moment_2
.
.
.
Load_n, X-Moment_n, Y-Moment_n
```

[Slenderness: Column]

This section contains 2 lines describing slenderness parameters for column being designed. The first line is for X-axis parameters, and the second line is for Y-axis parameters.

There are 5 values separated by commas in each line. These values are described below in the order they appear from left to right. (Menu Input | Slenderness | Design Column...)

1. Column clear height
2. k(braced)
3. k(sway)
4. 0-Non-sway frame; 1-Sway frame
5. 0-Compute 'k' factors; 1-Input k factors

[Slenderness: Column Above And Below]

This section contains 2 lines describing slenderness parameters for column above and column below. The first line is for column above, and the second line is for column below. (Menu Input | Slenderness | Columns Above/Below...)

There are 6 values separated by commas in line 1 for column above. These values are described below in the order they appear from left to right.

1. 0-Column specified; 1-No column specified
2. Column Height
3. Column width (along X)
4. Column depth (along Y)
5. Concrete compressive strength, f'_c
6. Concrete modulus of elasticity, E_c

There are 6 values separated by commas in line 2 for column below. These values are described below in the order they appear from left to right.

1. 0-Column specified; 1-No column specified
2. Column Height
3. Column width (along X)
4. Column depth (along Y)
5. Concrete compressive strength, f'_c
6. Concrete modulus of elasticity, E_c

[Slenderness: Beams]

This section contains 8 lines. Each line describes a beam.

- Line 1: X-Beam (perpendicular to X), Above Left
- Line 2: X-Beam (perpendicular to X), Above Right
- Line 3: X-Beam (perpendicular to X), Below Left
- Line 4: X-Beam (perpendicular to X), Below Right
- Line 5: Y-Beam (perpendicular to Y), Above Left
- Line 6: Y-Beam (perpendicular to Y), Above Right
- Line 7: Y-Beam (perpendicular to Y), Below Left
- Line 8: Y-Beam (perpendicular to Y), Below Right

There are 7 values separated by commas for each beam in each line. (Menu Input | Slenderness | X-Beams..., Input | Slenderness | Y-Beams...) These values are described below in the order they appear from left to right.

1. 0-beam specified; 1-no beam specified
2. Beam span length (c/c)
3. Beam width
4. Beam depth
5. Beam section moment of inertia
6. Concrete compressive strength, f'_c
7. Concrete modulus of elasticity, E_c

[EI]

Reserved. Do not edit.

[SldOptFact]

There is 1 value in this section for slenderness factors. (Code Default and User Defined radio buttons on menu Input | Slenderness | factors...)

0-Code default; 1-User defined

[Phi_Delta]

There is 1 value in this section for slenderness factors. (Menu Input | Slenderness | factors...)

Stiffness reduction factor

[Cracked I]

There are 2 values separated by commas in one line in this section. These values are described below in the order they appear from left to right. (Menu Input | Slenderness | factors...)

1. Beam cracked section coefficient
2. Column cracked section coefficient

[Service Loads]

This section describes defined service loads. (Menu Input | Loads | Service...) The first line contains the number of service loads. Each of the following lines contains values for one service load.

There are 25 values for each service load in one Line separated by commas. These values are described below in the order they appear from left to right.

1. Dead Axial Load
2. Dead X-moment at top
3. Dead X-moment at bottom
4. Dead Y-moment at top
5. Dead Y-moment at bottom
6. Live Axial Load
7. Live X-moment at top
8. Live X-moment at bottom
9. Live Y-moment at top
10. Live Y-moment at bottom
11. Wind Axial Load
12. Wind X-moment at top
13. Wind X-moment at bottom
14. Wind Y-moment at top
15. Wind Y-moment at bottom
16. EQ. Axial Load
17. EQ. X-moment at top
18. EQ. X-moment at bottom
19. EQ. Y-moment at top
20. EQ. Y-moment at bottom
21. Snow Axial Load
22. Snow X-moment at top
23. Snow X-moment at bottom
24. Snow Y-moment at top
25. Snow Y-moment at bottom

[Load Combinations]

This section describes defined load combinations. (Menu Input | Loads | Load Combinations...) The first line contains the number of load combinations. Each of the following lines contains load factors for one load combination.

```

Number of load combinations, n
Dead_1, Live_1, Wind_1, E.Q._1, Snow_1
Dead_2, Live_2, Wind_2, E.Q._2, Snow_2
.
.
.
Dead_n, Live_n, Wind_n, E.Q._n, Snow_n

```

[BarGroupType]

There is 1 value in this section. (Bar Set drop-down list on menu Options | Reinforcement...)

- 0-User defined
- 1-ASTM615
- 2-CSA G30.18
- 3-prEN 10080
- 4-ASTM615M

[User Defined Bars]

This section contains user-defined reinforcing bars. (Menu Options | Reinforcement...) The first line contains the number of defined bars. Each of the following lines contains values for one bar separated by commas.

```
Number of user-defined bars, n
Bar_1_size, Bar_1_diameter, Bar_1_area, Bar_1_weight
Bar_2_size, Bar_2_diameter, Bar_2_area, Bar_2_weight
.
.
.
Bar_n_size, Bar_n_diameter, Bar_n_area, Bar_n_weight
```

Conversion Factors - English to SI

To convert from	To	Multiply by
in.	m (1000 mm)	0.025400
ft	m	0.304800
lb	N (0.001 kN)	4.448222
kip (1000 lbs)	kN	4.448222
plf (lb/ft)	N/m	14.593904
psi (lb/in. ²)	kPa	6.894757
ksi (kips/in. ²)	MPa	6.894757
psf (lb/ft ²)	N/m ² (Pa)	47.88026
pcf (lb/ft ³)	kg/m ³	16.018460
ft-kips	kN • m	1.355818

Conversion Factors - SI to English.

To convert from	To	Multiply by
m (1000 mm)	in	39.37008
m	ft	3.28084
N (0.001 kN)	lb	0.224809
kN	kip (1000 lbs)	0.224809
kN/m	plf (lb/ft)	68.52601
MPa	psi (lb/in. ²)	145.0377
MPa	ksi (kips/in. ²)	0.145038
kN/m ² (kPa)	psf (lb/ft ²)	20.88555
kg/m ³	pcf (lb/ft ³)	0.062428
kN • m	ft-kips	0.737562

Contact Information

Web Site: <http://www.StructurePoint.org>

E-mail: info@StructurePoint.org
support@StructurePoint.org

StructurePoint, LLC.
5420 Old Orchard Road
Skokie, IL 60077
USA

Phone: (847) 966-4357

Fax: (847) 966-1542